

Environmental Specifications

Specification	Value
Rated Temperature Range (meets component specifications; however, please note that the inverter output wattage is derated above 25°C)	-4°F to 122°F (-20°C to 50°C)
Operational Temperature Range (functions, but not rated for operation; does not necessarily meet all component specifications)	-40°F to 140°F (-40°C to 60°C)
Storage Temperature Range	-40°F to 140°F (-40°C to 60°C)
IP (Ingress Protection) Rating of Enclosure	IP20
Environmental Category	Indoor, Unconditioned
Wet Locations Classification	Wet locations: No
Relative Humidity Rating	93%
Pollution Degree Classification	PD 2
Maximum Altitude Rating	6561' (2000 m)
Overvoltage Category (AC Input)	3
Overvoltage Category (DC Input)	1

All Radian inverters can deliver their full rated wattage at temperatures up to 25°C (77°F). The Radian maximum wattage is rated less in higher temperatures. Above 25°C, the GS8048A is derated by a factor of 80 VA for every increase of 1°C. The GS4048A is derated by 40 VA per 1°C. This derating applies to all power conversion functions (inverting, charging, selling, offsetting, etc.)



IMPORTANT:

This inverter is intended for indoor use only. Failure to adequately protect the inverter will void the warranty.

Contact Information

Mailing Address: Corporate Headquarters
17825 – 59th Avenue NE
Suite B
Arlington, WA 98223 USA

Web Site: www.outbackpower.com

European Office
Hansastraße 8
D-91126
Schwabach, Germany

Warranty Summary

OutBack Power Technologies warrants that the products it manufactures will be free from defects in materials and workmanship for a period of five (5) years subject to the conditions set forth in the warranty documentation.

OutBack Power Technologies cannot be responsible for system failure, damages, or injury resulting from improper installation of their products.

Notice of Copyright

Radian Series Inverter/Charger Quick Start Guide © 2017 by OutBack Power Technologies. All Rights Reserved.

Date and Revision

July 2017, Revision A

RADIAN Series Inverter/Charger

This Quick Start Guide is printed in unbound format. The pages can be read in any order, or shown alongside one another.



WARNING: Fire/Explosion Hazard

Do not place combustible or flammable materials within 12 feet (3.7 m) of the equipment. This unit employs mechanical relays and is not ignition-protected. Fumes or spills from flammable materials could be ignited by sparks.



WARNING: Personal Injury

Use safe lifting techniques and standard safety equipment when working with this equipment.



IMPORTANT:

Clearance and access requirements may vary by location. Maintaining a 36" (91.4 cm) clear space in front of the system for access is recommended. Consult local electric code to confirm clearance and access requirements for the specific location.



IMPORTANT:

These instructions are for use by qualified personnel who meet all local and governmental code requirements for licensing and training for the installation of electrical power systems with AC and DC voltage up to 600 volts. This product is only serviceable by qualified personnel.



NOTE:

For specifications, functions, applications, stacking, and programming instructions (or if installing with hardware not sold by OutBack), see the Radian product literature. For menu navigation, see the system display product literature. These documents are available at www.outbackpower.com. 



IMPORTANT:
Not intended for use with
life support equipment.

Radian Inverter/Charger

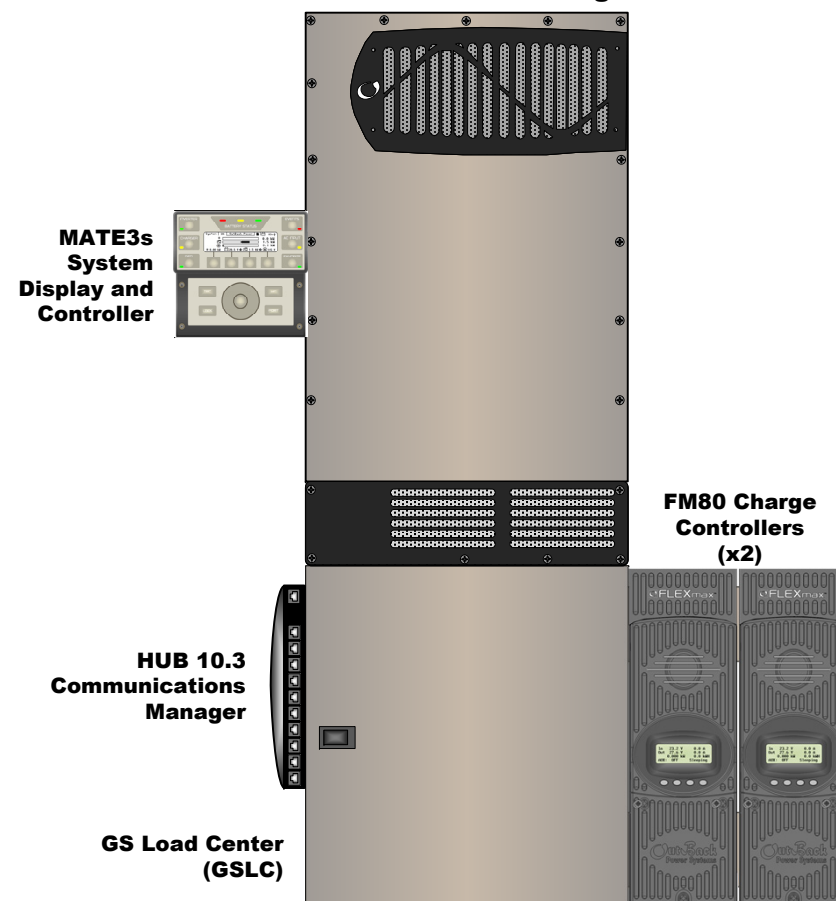

OPTICS RE Compatible

Major Components

Radian Inverter/Charger	GS8048A GS4048A
Radian System Products (optional; depicted as being installed)	
GS Load Center	GSLC175-PV-120/240 GSLC175PV1-120/240 (both depicted)
System Display and Controller	MATE3s depicted
Communications Manager	HUB10.3 depicted
Charge Controller	FLEXmax 80 depicted
FLEXnet DC Monitor (FN-DC)	
Remote Temperature Sensor	

Other Components

Battery Bank	
AC Source	Utility Grid or AC Generator
Main Electrical Panel and Distribution Subpanel (Load Panel)	
Photovoltaic (PV) Array and Combiner	

Installation

BEFORE STARTING

- This product is for indoor use only
- These instructions generally assume the use of OutBack products from the front page; instructions may differ if not used
- If GSLC is not used, make certain all electrical connections meet local safety standards and codes

Materials In Box

- Inverter
- Mounting Bracket
- Hardware Kit
- Quick Start Guide (this document)
- RTS (Remote Temperature Sensor)

Tools Required

- Wrench and socket sets; should include
 - torque and ratchet wrenches
 - reversible (stubby) wrenches for narrow access
 - offset box wrench, 1/2" or 13 mm
- Wire cutters/strippers
- Insulated screwdriver set (flat and Phillips); should include
 - #2 Phillips screwdriver 15 to 16" long
- Long-nose pliers
- High-resolution voltmeter

- 1 Ensure the mounting surface is strong enough to handle 3 times the total weight of all the components. Add plywood or other reinforcing material as necessary to strengthen the surface.
- 2 Attach the wall bracket. Center the mounting holes on the wall studs. Use all 6 mounting screws to secure the bracket.
- 3 Lift the inverter so that the inverter bracket is above the wall bracket.
- 4 Lower the inverter so that the inverter bracket slips into the wall bracket.
- 5 To install the GSLC, unscrew the inverter bottom screws approximately 1/4" (0.6 cm) to 3/16" (0.5 cm).
- 6 Align the GSLC along the bottom of the inverter. Slide the bottom screws into the keyhole slots.
- 7 Mark the spots for the GSLC mounting feet. (If necessary, remove the GSLC to install wall anchors.) Install screws to secure the feet.
- 8 Follow the appropriate instructions for installing other components. Different mounting locations are available.

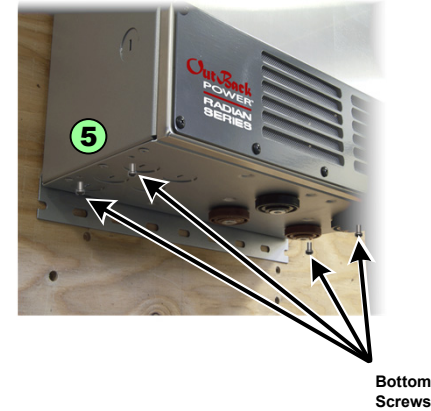

Bottom Screws

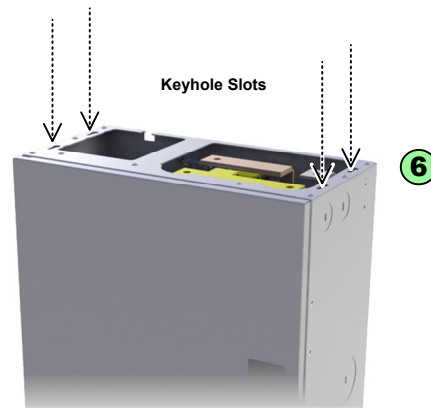

Keyhole Slots

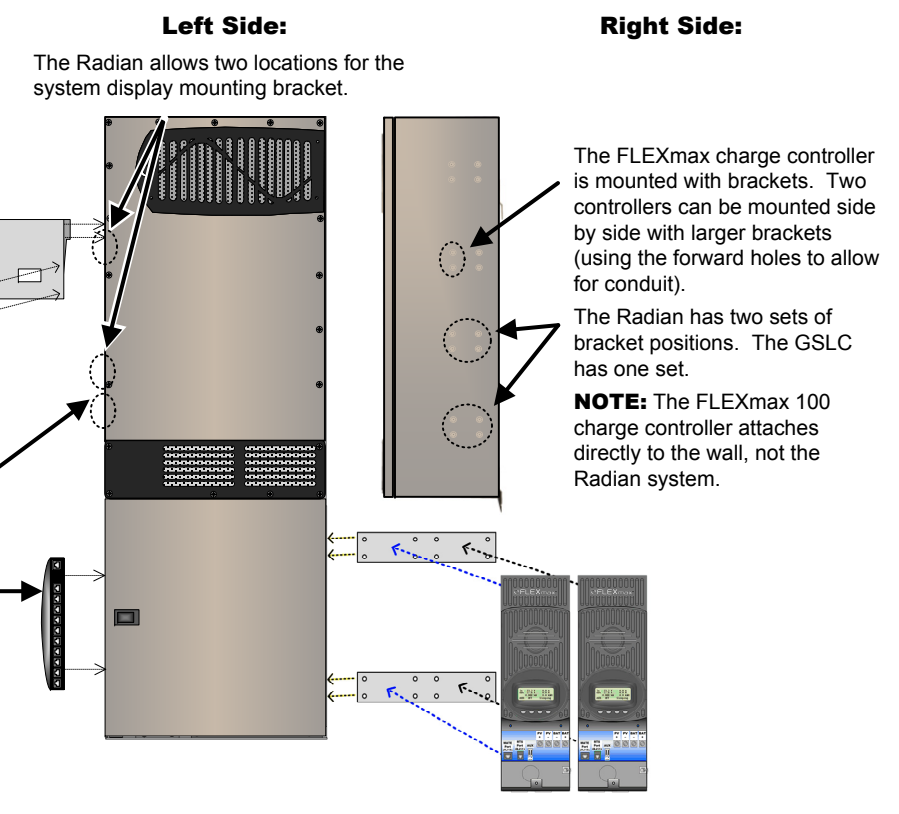
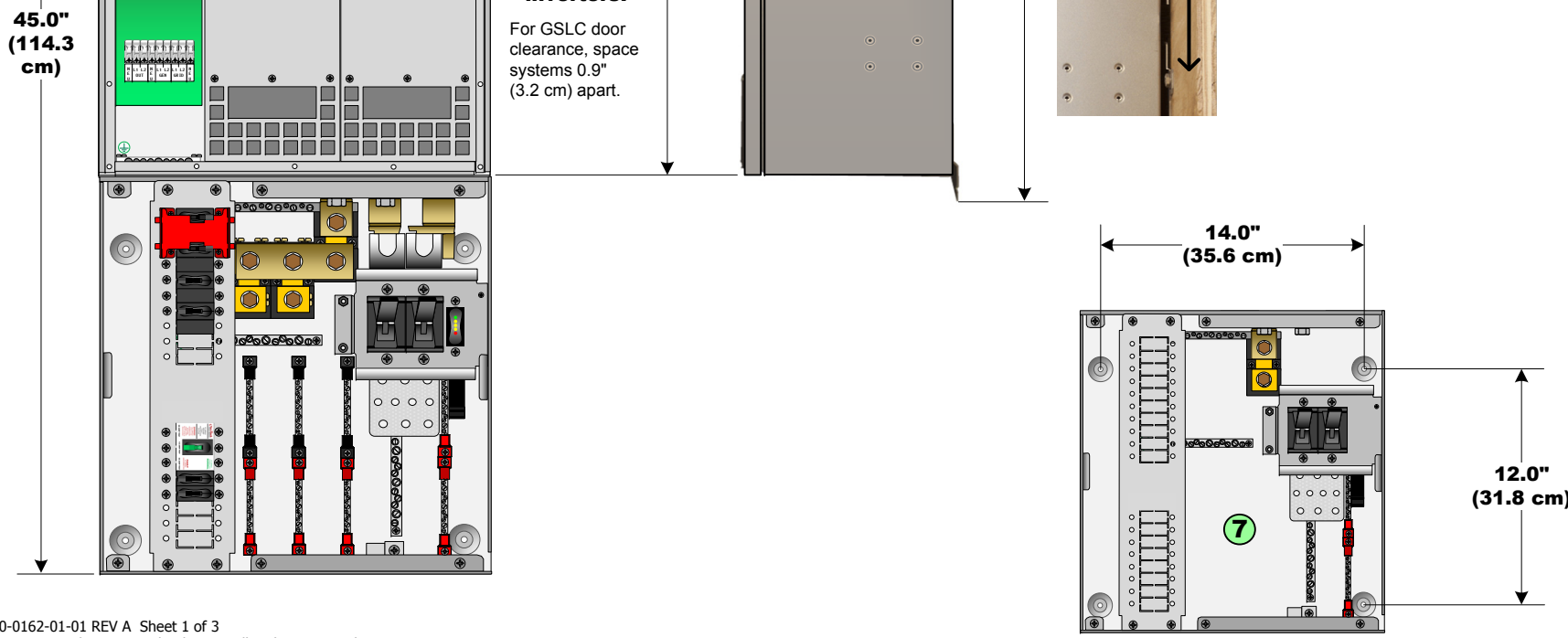
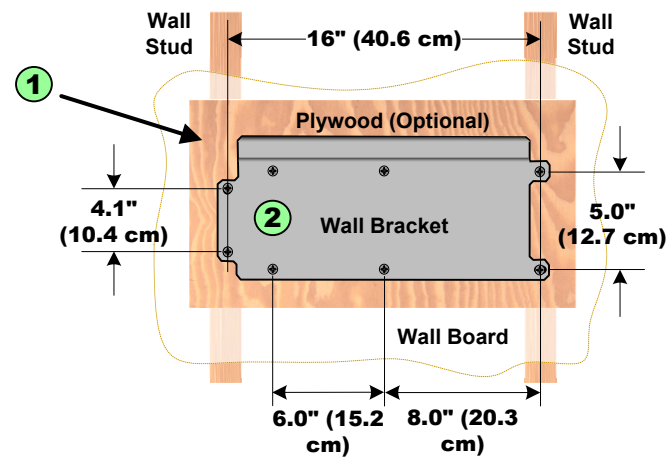
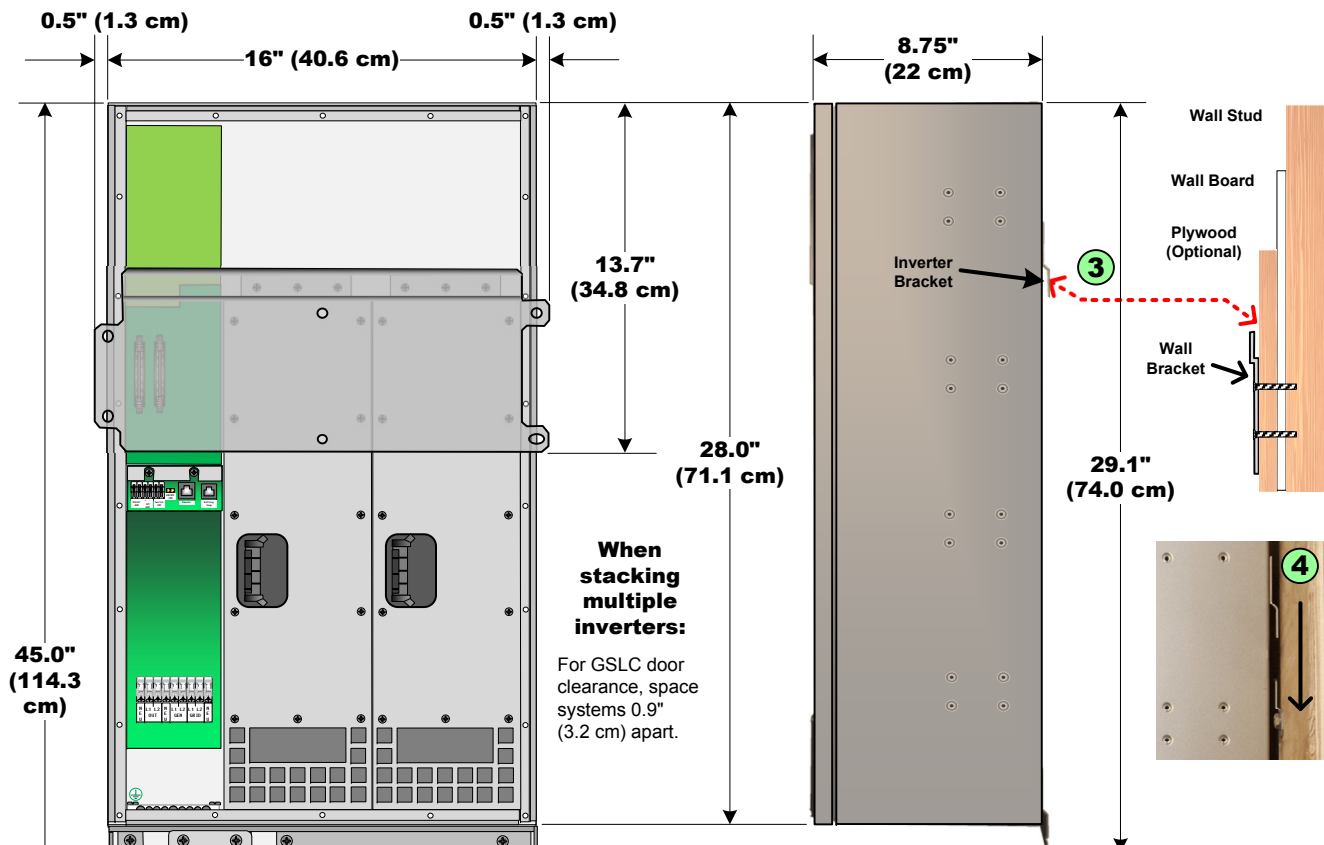

Wiring Data



CAUTION: Equipment Damage

When connecting cables from the Radian inverter to the battery terminals, observe the proper polarity. Incorrect connection can damage or destroy the equipment and void the warranty.

- 1 AC Terminals – Inverter
- 2 DC Terminals – Inverter
- 3 AC Circuit Breakers
- 4 DC Circuit Breakers
- 5 GFDI
- 6 PV Circuit Breakers
- 7 Mechanical Interlock (Bypass)
- 8 Charge Controller Terminals
- 9 Communication Ports
- 10 Auxiliary Terminals
- 11 AC OUT Bus Bar L1
- 12 AC OUT Bus Bar L2
- 13 GRID IN Bus Bar L1
- 14 GRID IN Bus Bar L2
- 15 GEN IN Bus Bar L1
- 16 GEN IN Bus Bar L2
- 17 AC Neutral
- 18 Ground
- 19 DC Positive (+) Plate (not used on GSLC175PV1-120/240)
- 20 PV Negative (-) Terminals
- 21 PV Positive (+) Bus Bars
- 22 DC Negative (-) Plate (GS-SBUS)

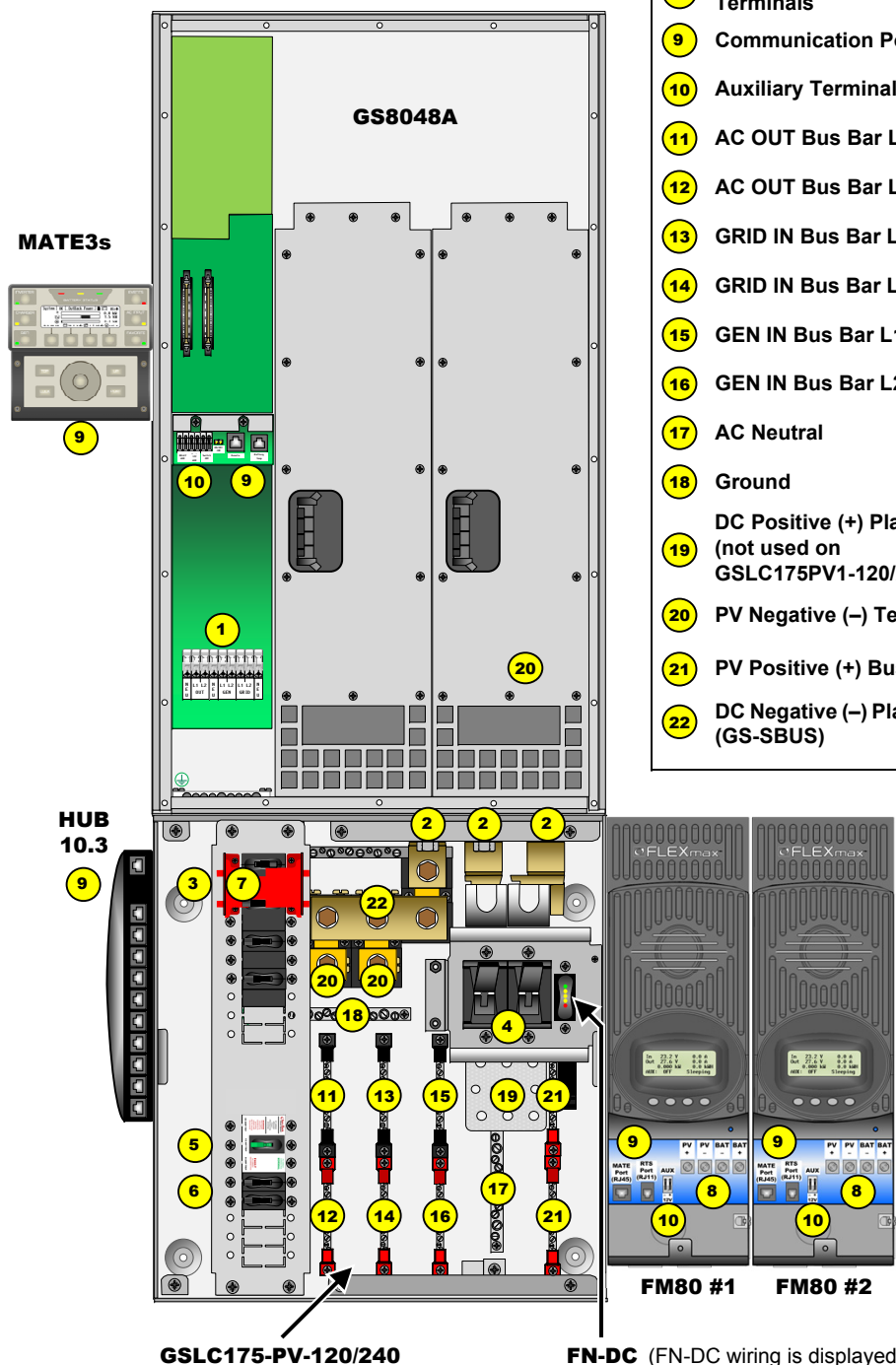

Torque Requirements

Circuit Breaker Stud	Torque	
	In-lb	Nm
M8	20	2.3
1/4 - 20	35	4.0
5/16 - 18	50	5.6
3/8 - 16	225	25.4
DC Plates	Torque	
	In-lb	Nm
Upper holes (+)	60	6.8
Lower holes (+)	50	5.6
Shunt Bolts (-), GS-SBUS, Inverter DC terminals	60	6.8

Minimum DC Cable based on the DC Circuit Breaker

Circuit Breaker	Cable Size	Torque	
		In-lb	Nm
60	#6 AWG (16 mm ²)	35	4.0
80	#4 AWG (25 mm ²)	35	4.0
125	1/0 (70 mm ²)	50	5.6
175*	2/0 (70 mm ²)	225	25.4
250	4/0 (120 mm ²)	225	25.4

*Minimum recommended size per DC disconnect for both GS4048A and GS8048A



IMPORTANT

- ❖ This product requires batteries for operation. The required nominal voltage is 48 Vdc.
- ❖ This inverter/charger product uses a three-stage cycle to charge batteries. The default settings are for lead-chemistry batteries intended for deep discharge. These include all energy storage offered by OutBack Power. OutBack recommends the use of batteries designed specifically for renewable energy applications.
- ❖ Protection for the battery circuit external to this product must be provided by the installer.
- ❖ Protection for the AC circuit external to this product must be provided by the installer.
- ❖ Prewired load centers are for single inverters only. See application notes on the OutBack website for applications with multiple inverters.

Positive Battery Cable Connections

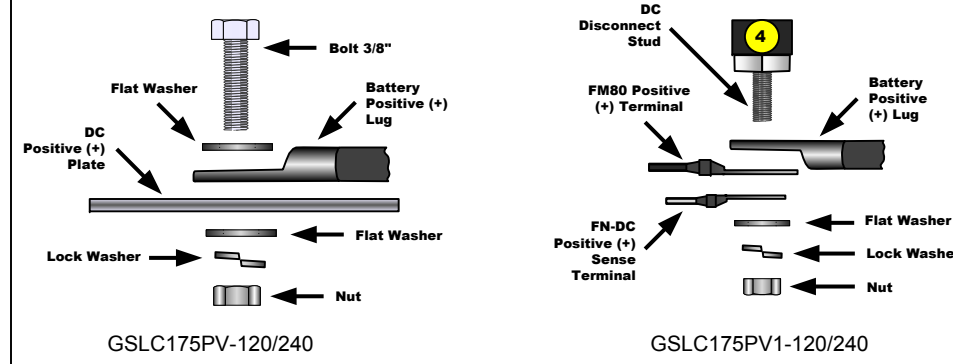

Negative Battery Cable Connections

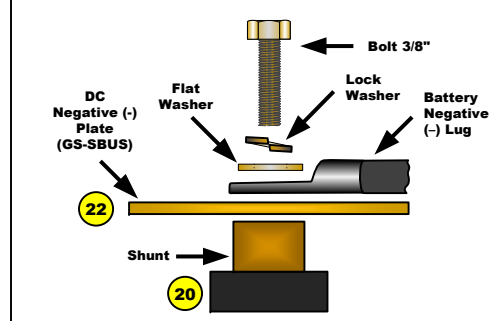

DC Wiring Notes

- Battery cables should be no longer than 10 feet (3 m) each to minimize voltage loss and other possible effects.
- Turn off DC circuit breakers or remove fuses before proceeding.
- Tie, tape, or twist cables together to reduce self-inductance. Run positive and negative cables through the same knockouts and conduit.
- Each inverter battery terminal is a threaded stud which accepts a ring terminal lug. Use compression lugs or crimped and sealed copper ring lugs with 5/16 inch (0.79 cm) holes.
- Install overcurrent devices according to applicable codes.
- The DC terminals must be installed in an enclosure to meet NEC requirements. The GSLC meets this requirement. Note that the GSLC top can be removed for access.
- The modular construction of the GS8048A requires two DC circuit breakers or fuses. Both sets of positive terminals **2** must be connected to battery power.
- The GS4048A has two sets of positive terminals, but only the terminals on the left are functional. The terminals on the right **must not** be connected to battery power.

Grounding Notes

- This product meets the IEC requirements of Protection Class I.
- This product must be connected to a permanent wiring system that is grounded according to the IEC 60364 TN standard.
- The input and output are isolated from ground. The installer is responsible for grounding according to all applicable codes.
- The central AC ground terminals are common. Typically only one is used.
- Minimum conductor size for the ground TBB: #8 AWG (10 mm²) or 0.013 in². Torque requirements: 25 in-lb (2.8 Nm).



WARNING: Shock Hazard

- ❖ For safety, the neutral and ground conductors should be mechanically bonded. OutBack does not bond these conductors within the inverter.
- ❖ The GSLC is equipped with a neutral-ground bond. Remove this bond if the bond is required to be made at the main panel or another location. Make sure that no more than one bond is present in the AC system at any time.
- ❖ For all installations, the negative battery conductor should be bonded to the grounding system at only one point. If the OutBack GFDI is present, it can provide the bond.

AC Wire Sizes and Torque Values

Wire Size	AWG	mm ²	Torque	
			In-lb	Nm
#14 to #10	2.5 to 6		20	2.3
#8	10		25	2.8
#6 to #4	16 to 25		35	4.0
#3	35		35	4.0
#2	35		40	4.5
#1	50		50	5.6
1/0	70		50	5.6

OutBack recommends that conductors be #6 AWG THHN copper, or larger, rated to 75°C (minimum) unless local code requires otherwise.

AC Wiring Notes

- Recommended conductor size: #6 AWG (16 mm²) or 0.021 in²
- Inverter output varies with model; size the loads accordingly
- The transfer relay is rated 60 Aac; AC input and output may need to be protected with branch-rated circuit breakers of maximum 60 Aac size to meet applicable code requirements
- The neutral terminals are common; typically only one is used
- Only one AC source can be wired at a time; use an external selector switch if more than one source is available

Generator Notes

- A generator should be sized to provide enough power for maximum loads and charging at the same time
- Minimum generator size is recommended to be twice the power of the inverter(s) due to overload and/or balancing issues

CAUTION: Fire Hazard
Before energizing, confirm that all hardware is installed as shown on the Installation page. Stacking battery terminal hardware in any other order can overheat the terminals.

Pre-startup Procedures:

1. Double-check all wiring connections. Ensure all torque values are met. See **Wiring Data**.
2. Inspect the enclosure to ensure no debris or tools have been left inside.
3. Disconnect all AC loads at the backup (or critical) load panel.
4. Disconnect the AC input feed to the GSLC at the source.

To energize or start the OutBack devices:

1. Using a digital voltmeter (DVM), verify 48 Vdc on the DC input terminals by placing the DVM leads on (1a) and (1b).

Confirm that the battery voltage is correct for the inverter and charge controller models.

Confirm the polarity.

CAUTION: Equipment Damage
Incorrect polarity will damage the equipment.

2. Turn on (close) the GFDI circuit breaker. **1**
3. Verify that the PV input for each charge controller is in the correct range of open-circuit voltage and confirm the polarity by:
 - a) placing the DVM leads on (2a) and (1b), and
 - b) placing the DVM leads on (2b) and (1b).
4. Turn on (close) the PV input circuit breakers. **2**
5. Turn on (close) the DC circuit breakers from the battery bank to the inverter. **3**
6. If the inverter is in the Off state, turn it On. **4** (See **NOTES**.)
7. Turn on (close) the AC output circuit breakers. **5**
8. Verify 120 Vac on the AC Output L1 TBB by placing the DVM leads on (3a) and (3c).
9. Verify 120 Vac on the AC Output L2 TBB (3b) and (3c).
10. Verify 240 Vac between the AC Output TBBs by placing the DVM leads on (3a) and (3b).
11. Start the generator if appropriate. Verify 120/240 Vac on the terminals of the AC input sources.
12. Turn on the AC input feed to the GSLC at the source.
11. Verify 120 Vac on the GRID IN L1 TBB by placing the DVM leads on (4a) and (3c).
12. Verify 120 Vac on the GRID IN L2 TBB (4b) and (3c).
13. Verify 240 Vac between the GRID IN TBBs by placing the DVM leads on (4a) and (4b).
14. Verify 120 Vac on the GEN IN L1 TBB by placing the DVM leads on (5a) and (3c).
15. Verify 120 Vac on the GEN IN L2 TBB (5b) and (3c).
16. Verify 240 Vac between the GEN IN TBBs by placing the DVM leads on (5a) and (5b).
17. Turn on (close) the AC input circuit breakers. **6**
18. Turn on the AC disconnects at the backup (or critical) load panel and test the loads.

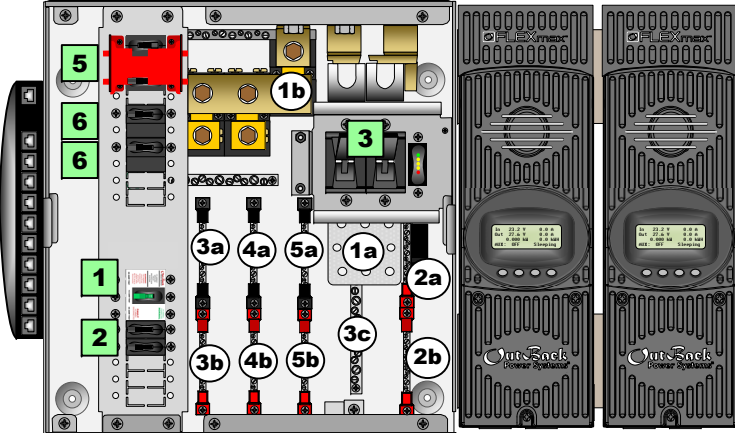
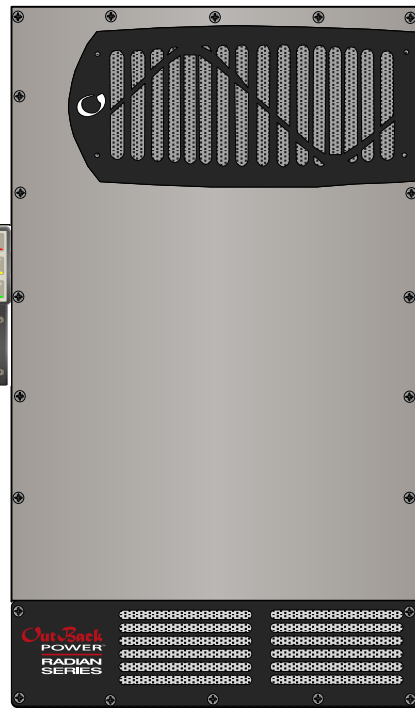
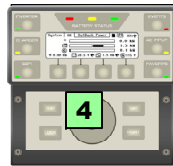

Functional Test Points

Battery Voltage Test Points (1a) (1b)
PV Voltage Test Points (2a) (2b) (2c) (2d) (1b)
AC OUT Voltage Test Points (Terminal bus bar = TBB) (3a) (3b) (3c)
GRID IN Voltage Test Points (Terminal bus bar = TBB) (4a) (4b) (3c)
GEN IN Voltage Test Points (Terminal bus bar = TBB) (5a) (5b) (3c)

Bypass Interlock Plate Position Key

The AC bypass allows a source to power the loads directly. The Radian can be shut down for maintenance or other reasons.

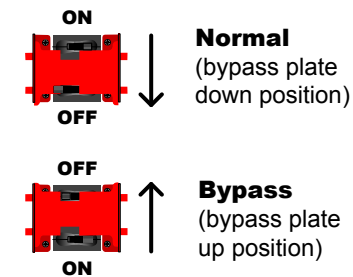

NOTES:

- If a system display is not present, the inverter must be turned off or on using an external switch or the J3 jumper. See the *Installation Manual* for more instructions.
- If any of these tests do not function as described, or for other troubleshooting, see the *Operator's Manual*.

These documents are available at www.outbackpower.com.

WARNING: Burn Hazard
Internal parts can become hot during operation. Do not remove the cover during operation or touch any internal parts. Be sure to allow them sufficient time to cool down before attempting to perform any maintenance.

WARNING: Lethal Voltage
Review the system configuration to identify all possible sources of energy. Ensure ALL sources of power are disconnected before performing any installation or maintenance on this equipment. Confirm that the terminals are de-energized using a validated voltmeter (rated for a minimum 1000 Vac and 1000 Vdc) to verify the de-energized condition.

WARNING: Lethal Voltage
The numbered steps will remove power from the inverter and charge controllers. However, sources of energy may still be present inside the GSLC and other locations. To ensure absolute safety, disconnect ALL power connections at the source.

Functional Test Points

Battery Voltage Test Points (1a) (1b) (1c) (1d)
PV Voltage Test Points (2a) (2b) (2c) (2d) (1b)
AC OUT Voltage Test Points (Terminal bus bar = TBB) (3a) (3b) (3c)

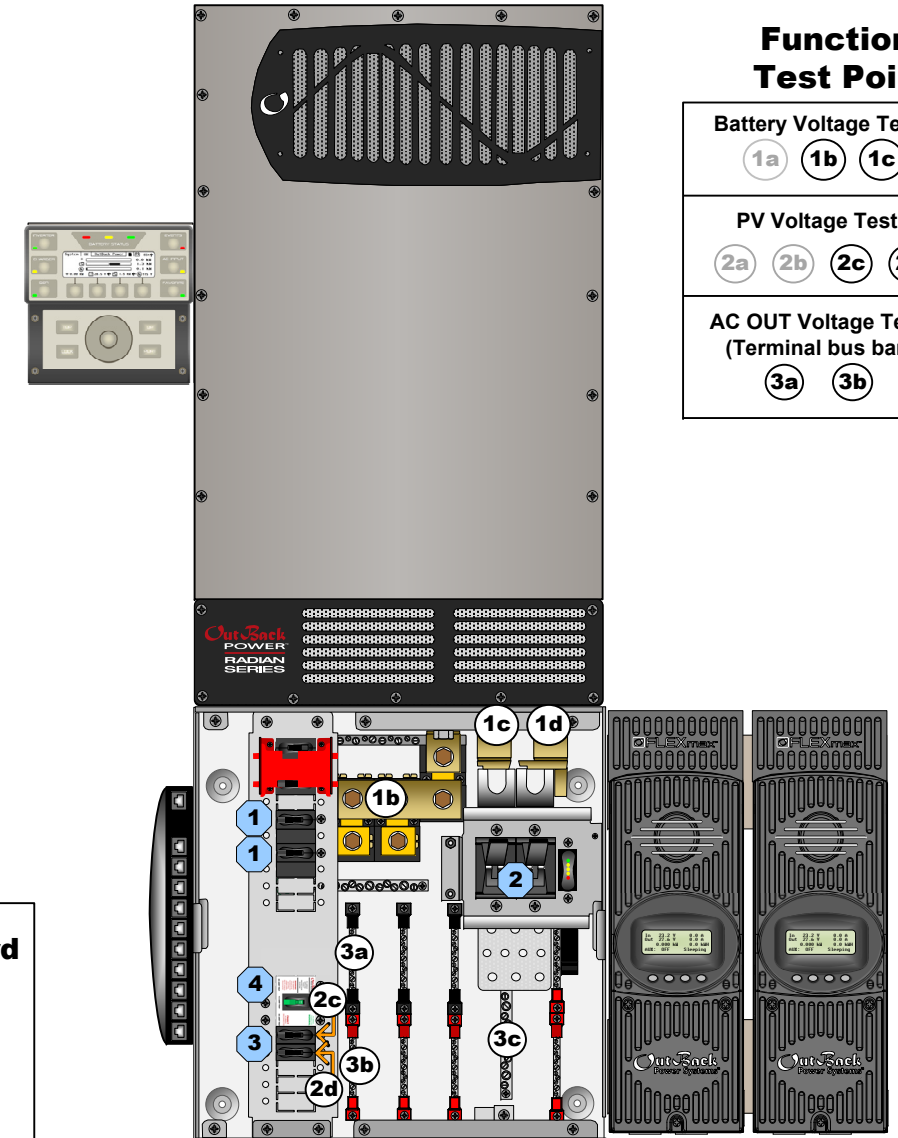

Test points 2c and 2d refer to the right terminal of each circuit breaker.

To de-energize or shut down the OutBack devices:

1. Turn off (open) the AC circuit breakers. **1**
2. Turn off (open) the DC circuit breakers for the battery. **2**
Wait 5 minutes for the devices to internally discharge themselves.
3. Turn off (open) the PV circuit breakers. **3**
4. Turn off (open) the GFDI circuit breaker. **4**
5. Verify 0 Vdc on the first DC bus of the inverter by placing the voltmeter leads on (1b) and (1c).
6. Verify 0 Vdc on the second DC bus by placing the voltmeter leads on (1b) and (1d).
7. Verify 0 Vdc on one PV circuit by placing the voltmeter leads on (2c) and (1b).
8. Verify 0 Vdc on the other PV circuit by placing the voltmeter leads on (2d) and (1b).
9. Verify 0 Vac on the AC output circuit breakers by placing the voltmeter leads on (3a) and (3c). Repeat this step for (3b) and (3c).

GS8048A wiring and external system

with GSLC175-PV-120/240 and grid bypass

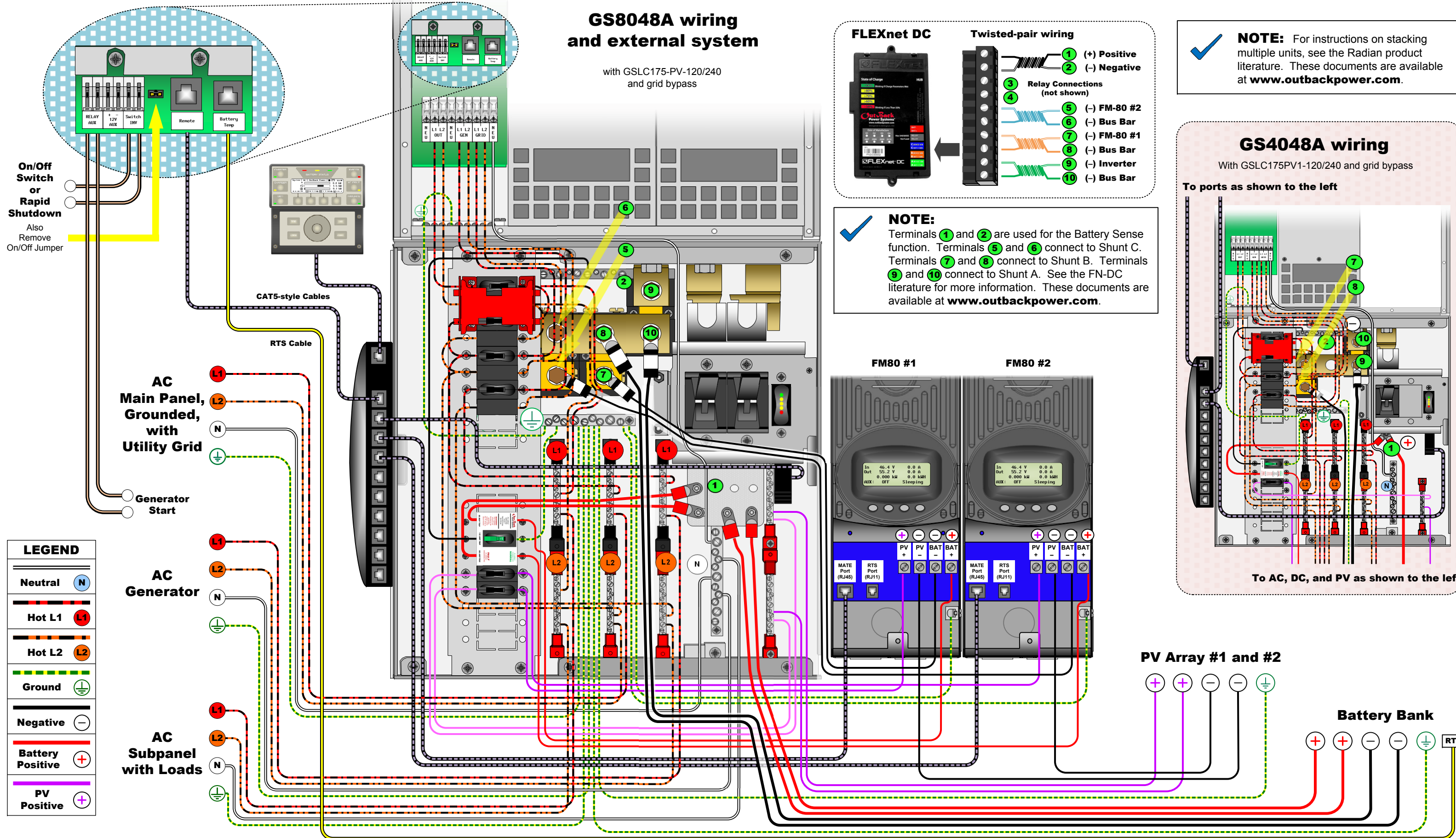

On/Off Switch or Rapid Shutdown
Also Remove On/Off Jumper

LEGEND	
Neutral	N
Hot L1	L1
Hot L2	L2
Ground	⊕
Negative	-
Battery Positive	+
PV Positive	+

FLEXnet DC Twisted-pair wiring

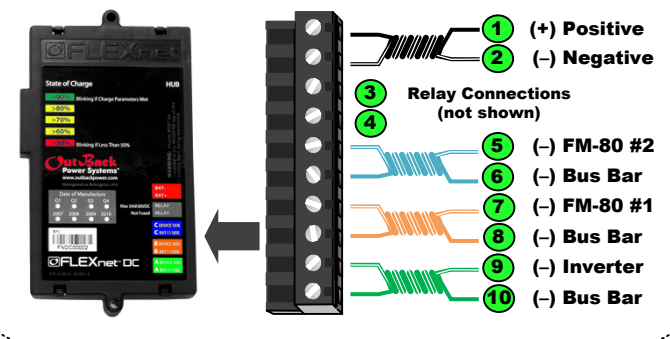

NOTE: Terminals 1 and 2 are used for the Battery Sense function. Terminals 5 and 6 connect to Shunt C. Terminals 7 and 8 connect to Shunt B. Terminals 9 and 10 connect to Shunt A. See the FN-DC literature for more information. These documents are available at www.outbackpower.com.

NOTE: For instructions on stacking multiple units, see the Radian product literature. These documents are available at www.outbackpower.com.

GS4048A wiring

With GSLC175PV1-120/240 and grid bypass

