



## **FXR Series Inverter/Charger**

**FXR2012A**

**FXR2524A**

**FXR3048A**

**VFXR2812A**

**VFXR3524A**

**VFXR3648A**



**GRIDHybrid™**

**Installation Manual**



**OPTICS RE** Compatible

## About OutBack Power Technologies

OutBack Power Technologies is a leader in advanced energy conversion technology. OutBack products include true sine wave inverter/chargers, maximum power point tracking charge controllers, and system communication components, as well as circuit breakers, batteries, accessories, and assembled systems.

## Applicability

These instructions apply to OutBack inverter/charger models FXR2012A, FXR2524A, FXR3048A, VFXR2812A, VFXR3524A, and VFXR3648A only.

## Contact Information

Address:	Corporate Headquarters 17825 – 59 <sup>th</sup> Avenue N.E. Suite B Arlington, WA 98223 USA	European Office Hansastraße 8 D-91126 Schwabach, Germany
Website:	<a href="http://www.outbackpower.com">http://www.outbackpower.com</a>	

## Disclaimer

UNLESS SPECIFICALLY AGREED TO IN WRITING, OUTBACK POWER TECHNOLOGIES:

- (a) MAKES NO WARRANTY AS TO THE ACCURACY, SUFFICIENCY OR SUITABILITY OF ANY TECHNICAL OR OTHER INFORMATION PROVIDED IN ITS MANUALS OR OTHER DOCUMENTATION.
- (b) ASSUMES NO RESPONSIBILITY OR LIABILITY FOR LOSS OR DAMAGE, WHETHER DIRECT, INDIRECT, CONSEQUENTIAL OR INCIDENTAL, WHICH MIGHT ARISE OUT OF THE USE OF SUCH INFORMATION. THE USE OF ANY SUCH INFORMATION WILL BE ENTIRELY AT THE USER'S RISK.

OutBack Power Technologies cannot be responsible for system failure, damages, or injury resulting from improper installation of their products.

Information included in this manual is subject to change without notice.

## Notice of Copyright

*FXR Series Inverter/Charger Installation Manual* © 2017 by OutBack Power Technologies.  
All Rights Reserved.

## Trademarks

OutBack Power, the OutBack Power logo, and Grid/Hybrid are trademarks owned and used by OutBack Power Technologies, Inc. The ALPHA logo and the phrase “member of the Alpha Group” are trademarks owned and used by Alpha Technologies Inc. These trademarks may be registered in the United States and other countries.

## Date and Revision

September 2017, Revision A

## Part Number

900-0166-01-01 Rev A



# Table of Contents

<b>Introduction</b> .....	<b>5</b>
Audience .....	5
Symbols Used .....	5
General Safety .....	5
Welcome to OutBack Power Technologies .....	6
Models .....	7
Inverter Model Names .....	7
Components and Accessories .....	7
<b>Planning</b> .....	<b>9</b>
Applications .....	9
Input Modes .....	10
Renewable Energy .....	11
Battery Bank .....	11
Generator .....	14
Generator Sizing .....	14
Three-Phase Source .....	14
<b>Installation</b> .....	<b>15</b>
Location and Environmental Requirements .....	15
Tools Required .....	15
Mounting .....	15
Dimensions .....	16
Terminals and Ports .....	17
Wiring .....	18
Grounding .....	18
DC Wiring .....	20
AC Wiring .....	23
AC Sources .....	24
ON and OFF Wiring .....	25
Accessory Wiring .....	26
AUX Wiring .....	26
Generator Control .....	28
AC Configurations .....	30
Single-Inverter .....	30
Multiple-Inverter AC Installations (Stacking) .....	31
Stacking Configurations .....	33
<b>Commissioning</b> .....	<b>45</b>
Functional Test .....	45
Pre-startup Procedures .....	45
Startup .....	45
Powering Down .....	47
Adding New Devices .....	47
Operation .....	47
Firmware Updates .....	48
.GIP File Installation for Grid Support .....	48
Preventative Maintenance .....	50
Definitions .....	50
<b>Index</b> .....	<b>53</b>

# List of Tables

Table 1	Models.....	7
Table 2	Components and Accessories .....	7
Table 3	Battery Bank Elements.....	12
Table 4	Ground Conductor Size and Torque Requirements.....	18
Table 5	DC Conductor Size and Torque Requirements.....	20
Table 6	Terms and Definitions .....	50

# List of Figures

Figure 1	FXR Series Inverter/Charger.....	6
Figure 2	Components.....	8
Figure 3	Applications (Example) .....	9
Figure 4	Dimensions .....	16
Figure 5	Terminals, Ports, and Features.....	17
Figure 6	DC Ground Lug.....	19
Figure 7	Chassis Ground/PE.....	19
Figure 8	Required Order of Battery Cable Hardware.....	21
Figure 9	Battery Terminal Covers .....	21
Figure 10	DC Cover Attachment .....	22
Figure 11	Turbo Fan Wiring .....	22
Figure 12	AC Terminals .....	23
Figure 13	AC Sources .....	24
Figure 14	AC Sources and Transfer Relay.....	24
Figure 15	ON/OFF Jumper and Connections.....	25
Figure 16	Accessory Connections.....	26
Figure 17	AUX Connections for Vent Fan (Example).....	27
Figure 18	AUX Connections for Diversion (Example) .....	27
Figure 19	Two-Wire Generator Start (Example).....	28
Figure 20	Three-Wire Generator Start (Example) .....	29
Figure 21	Single-Inverter Wiring.....	30
Figure 22	OutBack Communications Manager and System Display.....	31
Figure 23	Example of Series Stacking Arrangement.....	33
Figure 24	Series Wiring (Two Inverters).....	34
Figure 25	Example of Parallel Stacking Arrangement (Three Inverters).....	35
Figure 26	Parallel Wiring (Four Inverters) .....	36
Figure 27	Example of Series/Parallel Stacking Arrangement (Four Inverters).....	37
Figure 28	Series/Parallel Wiring .....	38
Figure 29	Example of Three-Phase Stacking Arrangement (Three Inverters) .....	39
Figure 30	Example of Three-Phase Stacking Arrangement (Nine Inverters) .....	39
Figure 31	Three-Phase Wiring (Three Inverters).....	41
Figure 32	Power Save Levels and Loads.....	42
Figure 33	Power Save Priority (Parallel) .....	44
Figure 34	Power Save Priority (Split-Phase).....	44
Figure 35	AC Terminals .....	46
Figure 36	Grid Support Screens.....	49







# Introduction

## Audience

This book provides instructions for the physical installation and wiring of this product. These instructions are for use by qualified personnel who meet all local and governmental code requirements for licensing and training for the installation of electrical power systems with AC and DC voltage up to 600 volts. This product is only serviceable by qualified personnel.

## Symbols Used



	<b>WARNING: Hazard to Human Life</b> This type of notation indicates that the hazard could be harmful to human life.
	<b>CAUTION: Hazard to Equipment</b> This type of notation indicates that the hazard may cause damage to the equipment.
	<b>IMPORTANT:</b> This type of notation indicates that the information provided is important to the installation, operation and/or maintenance of the equipment. Failure to follow the recommendations in such a notation could result in voiding the equipment warranty.
	<b>NOTE:</b> This type of notation indicates useful information. This symbol is not always used.



### MORE INFORMATION

When this symbol appears next to text, it means that more information is available in other manuals relating to the subject. The most common reference is to the *FXR Series Inverter/Charger Operator's Manual*. Another common reference is the system display manual.

## General Safety

	<b>WARNING: Limitations on Use</b> This equipment is NOT intended for use with life support equipment or other medical equipment or devices.
	<b>WARNING: Reduced Protection</b> If this product is used in a manner not specified by FXR product literature, the product's internal safety protection may be impaired.
	<b>CAUTION: Equipment Damage</b> Only use components or accessories recommended or sold by OutBack Power Technologies or its authorized agents.

# Welcome to OutBack Power Technologies

Thank you for purchasing the OutBack FXR Series Inverter/Charger. This product offers a complete power conversion system between batteries and AC power. It can provide backup power, sell power back to the utility grid, or provide complete stand-alone off-grid service.

- 12-, 24-, and 48-volt models
- Output power from 2.0 kVA to 3.6 kVA
- Designed to be integrated as part of an OutBack Grid/Hybrid™ system using FLEXware™ components
- Battery-to-AC inverting with single-phase adjustable output for such standards as 120 Vac, 100 Vac, or 127 Vac (at 60 or 50 Hz)
- AC-to-battery charging (FXR systems are battery-based)
- Uses battery energy stored from renewable resources
  - ~ Can utilize stored energy from PV arrays, wind turbines, etc.
  - ~ OutBack FLEXmax charge controllers will optimize PV output
- Inverter load support for a small AC source
- Sell-back to utility (grid-interactive function)
  - ~ Available in 24- and 48-volt models
- Rapid transfer between AC source and inverter output with minimal delay time
- Uses the MATE3™ class of System Display and Controller products, or the AXS Port™ SunSpec Modbus Interface (sold separately) for user interface as part of a Grid/Hybrid system
  - ~ MATE3s system display is required for grid support functionality; requires revision 1.001.000 or greater
- Supports the OPTICS RE™ online tool<sup>1</sup> for a cloud-based remote monitoring and control application
  - ~ Requires MATE3-class device or AXS Port
  - ~ Visit **[www.outbackpower.com](http://www.outbackpower.com)** to download
- Uses the HUB10.3™ Communications Manager for stacking as part of a Grid/Hybrid system
  - ~ Stackable in series, parallel, series/parallel, and three-phase configurations
- Listed by ETL to UL 1741 (2<sup>nd</sup> Edition with supplement SA) and CSA 22.2



**Figure 1 FXR Series Inverter/Charger**



**NOTE:**

This product has a settable AC output range. In this manual, many references to the output refer to the entire range. However, some references are made to 120 Vac or 60 Hz. These are intended as examples only.

## Models

Vented FXR (VFXR) models have an internal fan and use outside air for cooling. On average, VFXR models have higher power ratings than FXR models due to their greater cooling capabilities.

Sealed FXR models have an internal fan, but do not use outside air for cooling. To compensate, sealed models are also equipped with the OutBack Turbo Fan assembly, using external air to remove heat from the chassis. (Vented FXR models are not equipped with the Turbo Fan and cannot use it.)



### IMPORTANT:

All models, sealed or vented, must be installed indoors.

**Table 1 Models**

Model	Type	Power	Battery	Application
FXR2012A	Sealed	2.0 kVA	12 Vdc	Off-grid, backup
VFXR2812A	Vented	2.8 kVA	12 Vdc	Off-grid, backup
FXR2524A	Sealed	2.5 kVA	24 Vdc	Off-grid, backup, grid-interactive
VFXR3524A	Vented	3.5 kVA	24 Vdc	Off-grid, backup, grid-interactive
FXR3048A	Sealed	3.0 kVA	48 Vdc	Off-grid, backup, grid-interactive
VFXR3648A	Vented	3.6 kVA	48 Vdc	Off-grid, backup, grid-interactive

## Inverter Model Names

FXR series model numbers use the following naming conventions.

- The model number includes “FXR” as the inverter series. “R” indicates that the FXR was designed for renewable applications. Off-grid and grid-interactive functions are integrated in the same inverter.
- Vented models are preceded with “V”, as in “VFXR3648A”. If a model number does not begin with “V”, it is a sealed model and is equipped with a Turbo Fan. This is not indicated otherwise.
- The first two digits show the power of that model. For example, “FXR2012A” is 2000 watts.
- The second pair of digits shows the inverter’s nominal DC voltage. For example, “FXR2524A” is 24 volts.
- The model number is followed by “A”. This designates the inverter’s output as nominally 120 Vac (used in North America, Latin America, Asia, and other regions).

## Components and Accessories

**Table 2 Components and Accessories**

Components Included	Accessories Included
Battery Terminal Cover, red	FXR Series Inverter/Charger Quick Start Guide
Battery Terminal Cover, black	“WARNING ELECTRICAL SHOCK” sticker
AC Plate	Silicone Grease Packet
DC Cover (DCC) or Turbo Fan	
Remote Temperature Sensor (RTS)	

# Introduction

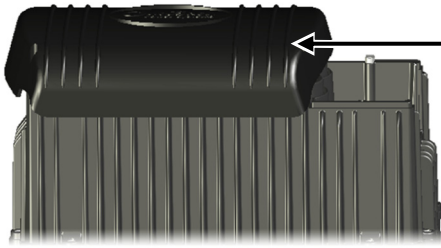

## DCC (DC Cover)

This covers the DC terminal area on vented inverters. The DCC provides space to mount other components such as a DC current shunt.



## AC Plate

This plate is used for installations which do not utilize OutBack's optional FLEXware conduit boxes. The knockouts are used to install strain relief for flexible cable.

**NOTE:** This plate is not to be connected to conduit.

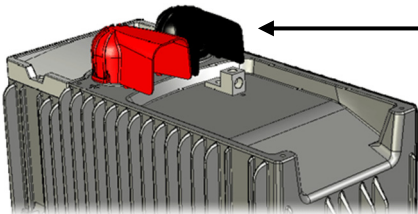

## Battery Terminal Cover

These protect the terminals from accidental contact. They are made of stiff plastic with a snap-on design.

Always keep covers installed during normal operation.

## Turbo Fan Cover

Included in place of the DCC on sealed inverters. Convectively cools chassis with the external OutBack Turbo Fan to allow maximum power.

**NOTE:** Do not install the Turbo Fan on a vented inverter.

**NOTE:** The DC Cover or Turbo Fan does not replace the battery terminal covers. These covers must be installed in addition to the DCC or Turbo Fan.

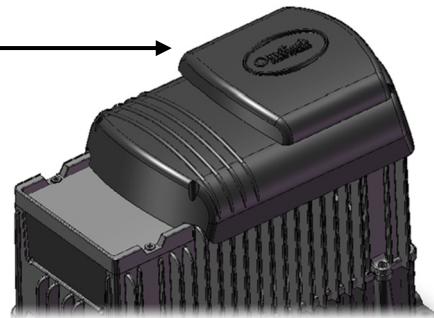

**Figure 2 Components**





# Planning

## Applications

OutBack inverterchargers are designed to use a battery bank to store energy. They work together with power from the utility grid or from renewable energy sources, such as photovoltaic (PV) modules, wind turbines, and other renewable sources. These sources charge the battery, which is used by the inverter.

The FXR inverter's settings can be changed to accommodate many applications.  These include off-grid, backup, and grid-interactive applications.

The FXR inverter has one set of terminals for a single AC source. However, it can use two different AC sources when an external transfer switch is installed. The inverter can be independently programmed for each source. It is common to use utility grid power and a gas or diesel generator. Other combinations of AC sources are possible.

This product includes grid support functionality according to UL1741 SA. See the *Operator's Manual* for more information. Contact the utility company for any specific installation requirements.

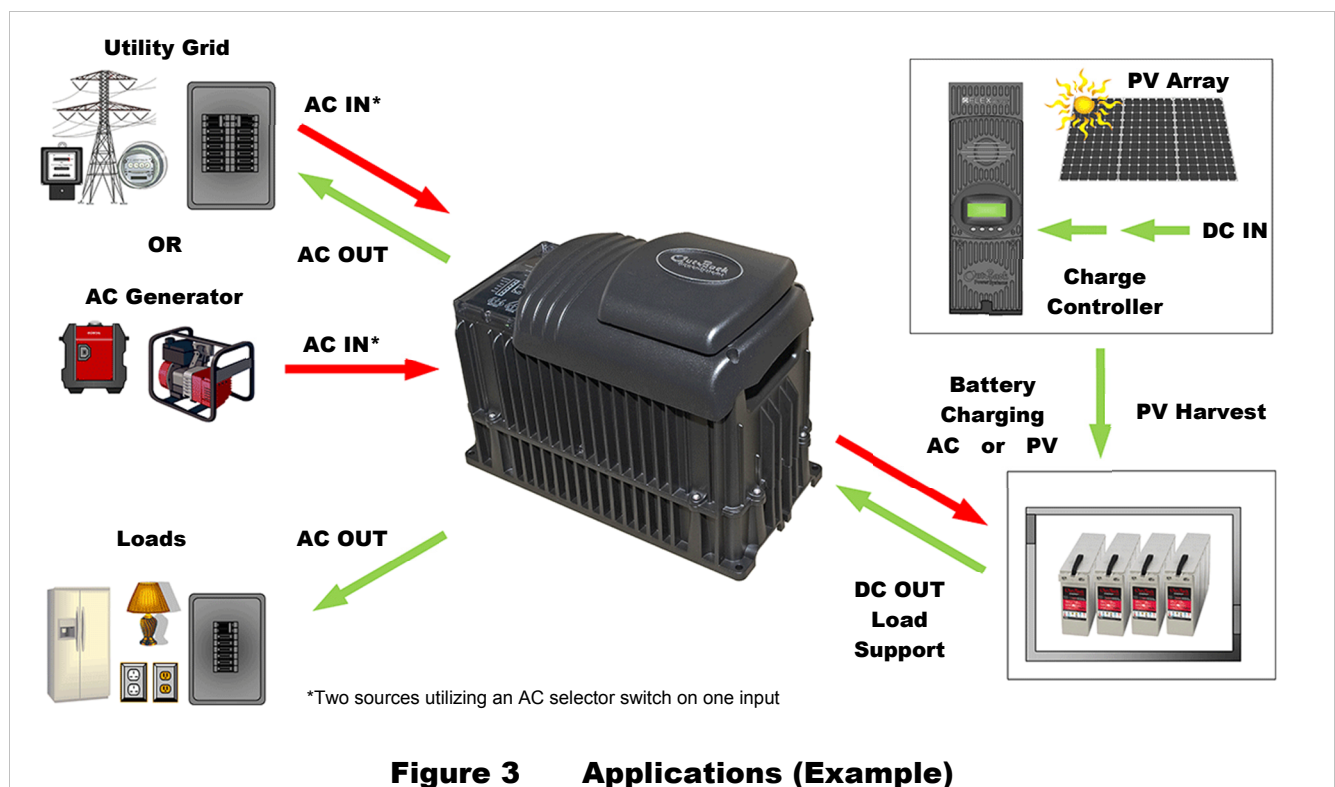

In Figure 3, the inverter uses a bidirectional AC input to sell power back to the utility grid. The power being delivered to the grid (labeled "AC Out") is excess AC power not being used by the AC loads. Selling requires an inverter/charger with **Grid Tied** mode available and active.

## Input Modes

The FXR inverter has many modes of operation. See the *FXR Series Inverter/Charger Operator's Manual* for additional information on these modes, including reasons and considerations for using each mode.

The modes determine how the inverter interacts with an AC source. Each mode has functions and priorities that are intended for a designated application. Each of the inverter's input selections can be set to a different operating mode to support different applications.

- **Generator:** This mode enables the battery charging function to tolerate a wider range of generator performance and waveform irregularities than other modes. The inverter can use generator power even when the generator is substandard.
- **Support:** This mode is intended for systems using utility grid or a generator. In some cases the amount of current available from the source is limited due to size, wiring, or other reasons. If large loads need to be run, the FXR inverter augments (supports) the AC source. The inverter uses battery power and additional sources to ensure that the loads receive the power they demand.
- **Grid Tied:** This mode is intended for grid-interactive systems that are net metered. Once the battery is charged and protected loads are served, the inverter will export power to the utility grid. Grid support functionality is available in this mode.

**NOTE: This mode is only available in 24-volt and 48-volt models.**

- **UPS:** This mode is intended for systems primarily intended to maintain power to the loads with minimal interruption when switching between AC input and batteries. The response speed has been increased so that if an AC disconnect occurs the response time will be minimized.
- **Backup:** This mode is intended for systems that have the utility grid or a generator available, but do not have specialty requirements such as selling or support. The AC source will flow through the inverter to power the loads unless power is lost. If power is lost, then the inverter will supply energy to the loads from the battery bank until the AC source returns.
- **Mini Grid:** This mode is intended for systems that have the utility grid as an input and a sizable amount of renewable energy. It behaves like an off-grid system using the utility grid as a backup generator. The system will use the renewable energy until the battery voltage falls to a specified low level. When this occurs, the inverter will connect to the utility grid to power the loads. The inverter will disconnect from the utility grid when the batteries are sufficiently recharged.
- **GridZero:** This mode is intended for systems that have the utility grid as an input and a sizable amount of renewable energy. The loads will remain connected to the utility grid, but will restrict the grid use except when no other power is available. The default power sources are the batteries and renewable energy, which attempt to "zero" the use of the AC source. The batteries are discharged and recharged (from renewable sources) while remaining grid-connected. This mode does not allow the inverter to charge batteries or sell. Grid support functionality is available in this mode.

See the *FXR Series Inverter/Charger Operator's Manual* for additional information on these modes, including the reasons and considerations for using each mode.

## Programming

Selection of the input modes and all other inverter programming is performed using a system display such as the MATE3s. This product can customize a wide range of parameters. 

## Renewable Energy

The FXR inverter cannot connect directly to PV, wind turbines, or other unregulated DC sources. The batteries are the inverter’s primary source of power.

A renewable energy source is always treated as a battery charger, even if all of its power is used immediately by the inverter. The renewable source must have a charge controller, or some other regulation method, to prevent overcharging. OutBack Power’s FLEXmax family of charge controllers can be used for this purpose, as can other products.

## Battery Bank



When planning a battery bank, consider the following:

- **Cables:** Recommendations for battery cable size and length are shown on page 20. The maximum length will determine the placement of the battery bank. Local codes or regulations may apply and may take priority over OutBack recommendations.
- **Battery Type:** The FXR inverter/charger uses a three-stage charge cycle.

The default inverter/charger settings assume a deep-cycle stationary lead-acid battery, such as OutBack’s EnergyCell RE or NC series batteries. The charging configuration is highly customizable so that lithium-ion and other advanced chemistry charging cycles can be accommodated. Consult the documentation for the specific batteries used in the system to ensure that the settings are appropriate. 

- **Nominal Voltage:** These inverters are designed to work with specific battery bank voltages, which are different depending on inverter model. Before constructing a battery bank, check the inverter model and confirm nominal battery voltage.
- **Charger Settings and Maintenance:** A vented battery enclosure may be required by electric code and is usually recommended for safety reasons. It may be necessary to use a fan to ventilate the battery enclosure.

Batteries must be regularly maintained according to the instructions of the battery manufacturer.

	<p><b>IMPORTANT:</b></p> <p>Battery charger settings need to be correct for a given battery type. Always follow battery manufacturer recommendations. Making incorrect settings, or leaving them at factory default settings, may cause the batteries to be undercharged or overcharged.</p>
	<p><b>CAUTION: Hazard to Equipment</b></p> <p>Batteries can emit vapors which are flammable and which are corrosive over long periods of time. Installing the inverter in the battery compartment may cause corrosion which is not covered by the product warranty. (Sealed batteries may be an exception.)</p>

- **Bank Size:** Battery bank capacity is measured in amp-hours. Determine the required bank specifications as accurately as possible, beginning with the items below. This avoids underperformance or wasted capacity.

These ten items are obtainable in different places, summarized in Table 3. Some of the information is specific to the site or application. Some can be obtained from the battery manufacturer. Information on OutBack products is available from OutBack Power Technologies or its dealers.

- A.** Size of load:
  - B.** Daily hours of use:
  - C.** Days of autonomy:
- } These are the most basic and essential factors used to determine bank size.
- D.** Application: This often helps define or prioritize the previous three items. Off-grid systems often require enough capacity to last for an extended period before recharging. Grid-connected systems frequently need only enough capacity for short-term backup during outages.
  - E.** Conductor efficiency: Wire size and other factors will waste power due to resistance and voltage drop. Typical acceptable efficiency is 96 to 99%.
  - F.** Inverter efficiency: FXR specifications list “Typical Efficiency” to help estimate operating loss.
  - G.** System DC voltage: Each inverter model requires a specific DC voltage to operate.
- } Any losses are essentially amp-hour capacity that the system cannot use. The battery bank size can be increased to account for losses.

- H.** Battery voltage: Most individual battery voltages are less than the system DC voltage. The batteries may need to be placed in series to deliver the correct voltage.
- I.** Capacity: Battery capacity, which is measured in ampere-hours (amp-hours or Ah), is not usually a fixed number. It is specified based on the rate of discharge. For example, the OutBack EnergyCell 200RE is rated at 128.4 Ah when discharged at the 4-hour rate (to terminal voltage 1.85 Vpc). This is a high rate of discharge that would hypothetically drain the battery in 4 hours. The same battery is rated at 170 Ah when used at the 20-hour rate.

In general, use the 8-hour capacity or less. The larger the load, the more severe the discharge. In these cases conservative values with faster discharge times from the table (for example, the 2- or 3-hour capacity) are better.

To choose accurately, the best method is to divide each Ah figure by the discharge in hours. (An example from Table 3 for the OutBack 200RE would be  $119.1 \div 3 \text{ hours} = 39.7 \text{ Adc.}$ ) If the number is equal or greater than the load size (in DC amperes), that column can be used as the capacity.

**NOTES:**

- ~ The battery’s selected rated capacity may have little to do with the actual hours of use; this figure simply reflects the rate of discharge.
- ~ Use battery specifications for terminal voltage 1.85 Vpc whenever possible.
- ~ Capacity ratings are for batteries at 25°C. Capacity is reduced at cooler temperatures.

- J.** Maximum depth of discharge (DoD): Most batteries cannot be discharged below a certain level without damage. The bank requires enough total capacity to keep this from happening. DoD is usually described as a percentage, although it is shown as a decimal in calculations.

**Table 3  
Battery Bank Elements**

Item	Source of information
<b>A.</b> Load Size	Site-specific
<b>B.</b> Daily Hours	Site-specific
<b>C.</b> Days of Autonomy	Site-specific
<b>D.</b> Application	Site-specific
<b>E.</b> Conductor Efficiency	Site-specific
<b>F.</b> Inverter Efficiency	Inverter manufacturer
<b>G.</b> System Vdc	Inverter manufacturer
<b>H.</b> Battery Vdc	Battery manufacturer
<b>I.</b> Capacity Ah	Battery manufacturer

**Example:**

Model	Discharge in Hours					
	1	2	3	4	8	20
200RE	82.0	120.0	119.1	128.4	148.8	170.0
220GH	127.3	151.4	162.9	169.6	190.8	206.0

- J.** Maximum DoD Battery manufacturer

## To Calculate Minimum Battery Bank Size (refer to previous page for letter designations):

1. The load size, item **A**, is measured in watts. Compensate this figure for efficiency loss. Multiply the conductor efficiency by the inverter efficiency (**E** x **F**). (These items are represented as percentages, but may be displayed as decimals for calculation.) Divide item **A** by the result.
2. Convert the compensated load into amperes (Adc). Divide the step **1** result by the system voltage (**G**).
3. Determine the best battery capacity (**I**) by dividing each rated capacity by the time in hours (as shown in Table 3). This is the estimated discharge rate at that battery capacity. The number is usable if the step **2** result (the actual load rate) does not exceed it. Choose the closest (or smaller) rated amp-hour capacity.
4. Determine the daily load consumption in ampere-hours (Ah). Multiply the step **2** result by the daily usage hours (item **B**).
5. Adjust the total for required days of autonomy (the days the system must operate without recharging) and the maximum DoD. Multiply the step **4** result by **C** and divide by **J**.

The result is the total amp-hour capacity required for the battery bank.

6. Determine the number of parallel battery strings required. Divide the Ah figure from step **5** by the individual battery capacity (**I**) determined in step **3**. Round the result to the next highest whole number.
7. Determine the total number of batteries required. Divide the system voltage by the battery voltage (**G** ÷ **H**). Multiply the result by the step **6** result.

The result is the total required quantity of the chosen battery model.

### EXAMPLE #1

<b>A.</b> Backup loads: 1.0 kW (1000 W)	<b>1. A ÷ [E × F]</b>	$1000 \div (0.98 \times 0.93) = 1097.2 \text{ W}$
<b>B.</b> Hours of use: 8	<b>2. 1 ÷ G</b>	$1097.2 \div 48 = 22.9 \text{ Adc}$
<b>C.</b> Days of autonomy: 1	<b>3. I = Ah ÷ hours</b>	$184.8 \div 8 = 23.1 \text{ Adc}$ (larger than 22.9; this means 184.8 Ah is acceptable)
<b>D.</b> Grid-interactive system (FXR3048A inverter)	<b>Compare to 2</b>	
<b>E.</b> Conductor efficiency: 98% (0.98)	<b>4. 2 × B</b>	$22.9 \times 8 = 182.9 \text{ Ah}$
<b>F.</b> Inverter efficiency: 93% (0.93)	<b>5. [4 × C] ÷ J</b>	$[182.9 \times 1] \div 0.8 = 228.6 \text{ Ah}$
<b>G.</b> System voltage: 48 Vdc	<b>6. 5 ÷ I</b>	$228.6 \div 184.8 = 1.24$ (rounded to 2)
<b>H.</b> Batteries: OutBack EnergyCell 220GH (12 Vdc)	<b>7. [G ÷ H] × 6</b>	$[48 \div 12] \times 2 \text{ strings} = 8 \text{ batteries}$
<b>I.</b> Capacity determined at 8-hour rate: 184.8 Ahr		
<b>J.</b> Maximum DoD: 80% (0.8)		

### EXAMPLE #2

<b>A.</b> Backup loads: 720 W	<b>1. A ÷ [E × F]</b>	$720 \div (0.97 \times 0.9) = 824.7 \text{ W}$
<b>B.</b> Hours of use: 2.5	<b>2. 1 ÷ G</b>	$824.7 \div 24 = 34.4 \text{ Adc}$
<b>C.</b> Days of autonomy: 2	<b>3. I = Ah ÷ hours</b>	$119.1 \div 3 = 39.7 \text{ Adc}$ (larger than 34.4; this means 119.1 Ah is acceptable)
<b>D.</b> Off-grid system (VFXR3524A inverter)	<b>Compare to 2</b>	
<b>E.</b> Conductor efficiency: 97% (0.97)	<b>4. 2 × B</b>	$34.4 \times 2.5 = 85.9 \text{ Ahr}$
<b>F.</b> Inverter efficiency: 92% (0.9)	<b>5. [4 × C] ÷ J</b>	$[85.9 \times 2] \div 0.5 = 343.6 \text{ Ahr}$
<b>G.</b> System voltage: 24 Vdc	<b>6. 5 ÷ I</b>	$343.6 \div 119.1 = 2.9$ (rounded to 3)
<b>H.</b> Batteries: OutBack EnergyCell 200RE (12 Vdc)	<b>7. [G ÷ H] × 6</b>	$[24 \div 12] \times 3 \text{ strings} = 6 \text{ batteries}$
<b>I.</b> Capacity determined at 3-hour rate: 119.1 Ahr		
<b>J.</b> Maximum DoD: 50% (0.5)		

## Generator

- FXR inverters can accept power from a single-phase generator that delivers clean AC power in the range of voltage and frequency specified for that model.
  - ~ Inverters stacked for split-phase output (120/240 Vac) can work with both output lines of a split-phase generator.
  - ~ Inverters stacked for three-phase output can work with three-phase (120V/208Y) generators.
- The inverter/charger can provide a start signal to control an automatic start generator. If automatic generator starting is required, the generator must be an electric-start model with automatic choke. It should have two-wire start capability. For other configurations, additional equipment may be required.
- In any configuration, the inverter may need to be specifically programmed using the system display.  Perform all programming according to the specifications of the generator and the required operation of the inverter. Parameters to be programmed may include generator size, automatic starting requirements, and potential fluctuations in generator AC voltage.
- A generator that is to be installed in a building usually should **not** have a bond between the neutral and ground connections. The generator should only be bonded if there is a specific need. Installations in North America are expected to bond the neutral and ground at the main electrical panel. See page 18 for more information on neutral-ground bonding.

## Generator Sizing

A generator should be sized to provide enough power for all expected use.

- A conservative estimate assumes that both the loads and charging will be maximized at the same time. However, this can result in an oversized generator with inefficient operation.
- A smaller generator may be used for average loads with the inverter's **Support** mode providing support from the batteries during peak loads. The loads can be manually disconnected while charging.
- In general, the generator should be sufficiently powerful to handle all necessary load surges.

Other considerations:

- Available generator power may be limited by ratings for circuit breakers and/or generator connectors.
- Many generators may not be able to maintain AC voltage or frequency for long periods of time if they are loaded more than 80% of rated capacity. This statement may not apply to inverter-based generators, which typically have more stable voltage and frequency regulation.
- If a split-phase 120/240 Vac generator is powering a single-phase 120 Vac inverter system with no other compensation, it may suffer from balancing issues. The OutBack FW-X240 or PSX-240 balancing transformers may compensate for this condition.

## Three-Phase Source

As noted above, FXR inverters stacked for three-phase power can accept three-phase (120V/208Y) sources. In addition, two inverters can accept two phases of a 120V/208Y three-phase source to power a split-phase load panel if necessary. There are several concerns when operating this way.

- The inverters must be stacked in three-phase configuration. One must be designated **Master** and the other as **B Phase Master**. See page 39 for more information.
- The inverters will continue to deliver 120V/208Y output. They can power 120 Vac loads, but cannot power 120/240 Vac loads.



# Installation

## Location and Environmental Requirements

FXR and VFXR series inverter/chargers must be located indoors or in a weather-proof enclosure. They are not designed for exposure to water, salt air, or excessive wind-blown dust and debris.

- The inverter can often be mounted in any position or orientation. When inverters are installed with an OutBack FLEXpower system, the system must be installed in the upright orientation due to the requirements of the circuit breakers.
- These inverters will perform more efficiently in locations offering plenty of air circulation. The minimum recommended clearance is 2 inches (5 cm) on all sides of the inverter.
- These inverters will operate normally in a range of  $-4^{\circ}\text{F}$  to  $122^{\circ}\text{F}$  ( $-20^{\circ}\text{C}$  to  $50^{\circ}\text{C}$ ). Maximum output will begin to decline at ambient temperatures above  $25^{\circ}\text{F}$  ( $77^{\circ}\text{C}$ ).
- The allowable temperature range for storage is  $-40^{\circ}\text{F}$  to  $140^{\circ}\text{F}$  ( $-40^{\circ}\text{C}$  to  $60^{\circ}\text{C}$ ).
- These inverters carry an Ingress Protection (IP) rating of 20 and a Relative Humidity (RH) rating of 93% (non-condensing).
- Inverter specifications are listed in the *FXR Series Inverter/Charger Operator's Manual*.

## Tools Required

The following tools may be required for this installation:

- Wrench and socket sets; should include
  - ~ torque and ratchet wrenches
- Wire cutters/strippers
- Insulated screwdriver set (flat and Phillips)
- Long-nose pliers
- High-resolution voltmeter

## Mounting

- One person can install the FXR inverter, but installation may be easier with two people.
- The unit has four mounting holes, one in each corner. Use fasteners in all corners.
- Due to the variance in other mounting methods, OutBack only endorses the use of FLEXware mounting products. Use M6 x 20 mm machine screws, one per corner, to attach the inverter to the mounting plate. Follow the instructions with each mounting system.
- Mount the plate on a flat, solid mounting surface. Ensure the surface is strong enough to handle three times the total weight of all the components. If using a FLEXware Mounting Plate, avoid large air gaps behind the plate. These can result in louder mechanical noise during heavy inverting or charging.
- Mount and secure each component before attaching any wiring.
- When the inverter is used with other metal chassis, make sure that all chassis are grounded appropriately. (See the grounding instructions on page 18.) Grounding other chassis may involve metal-to-metal contact, or separate ground wires.



### **IMPORTANT:**

Use correct fasteners to secure the inverter to the mounting surface, regardless of the type of surface. OutBack cannot be responsible for damage to the product if it is attached with inadequate fasteners.

# Dimensions

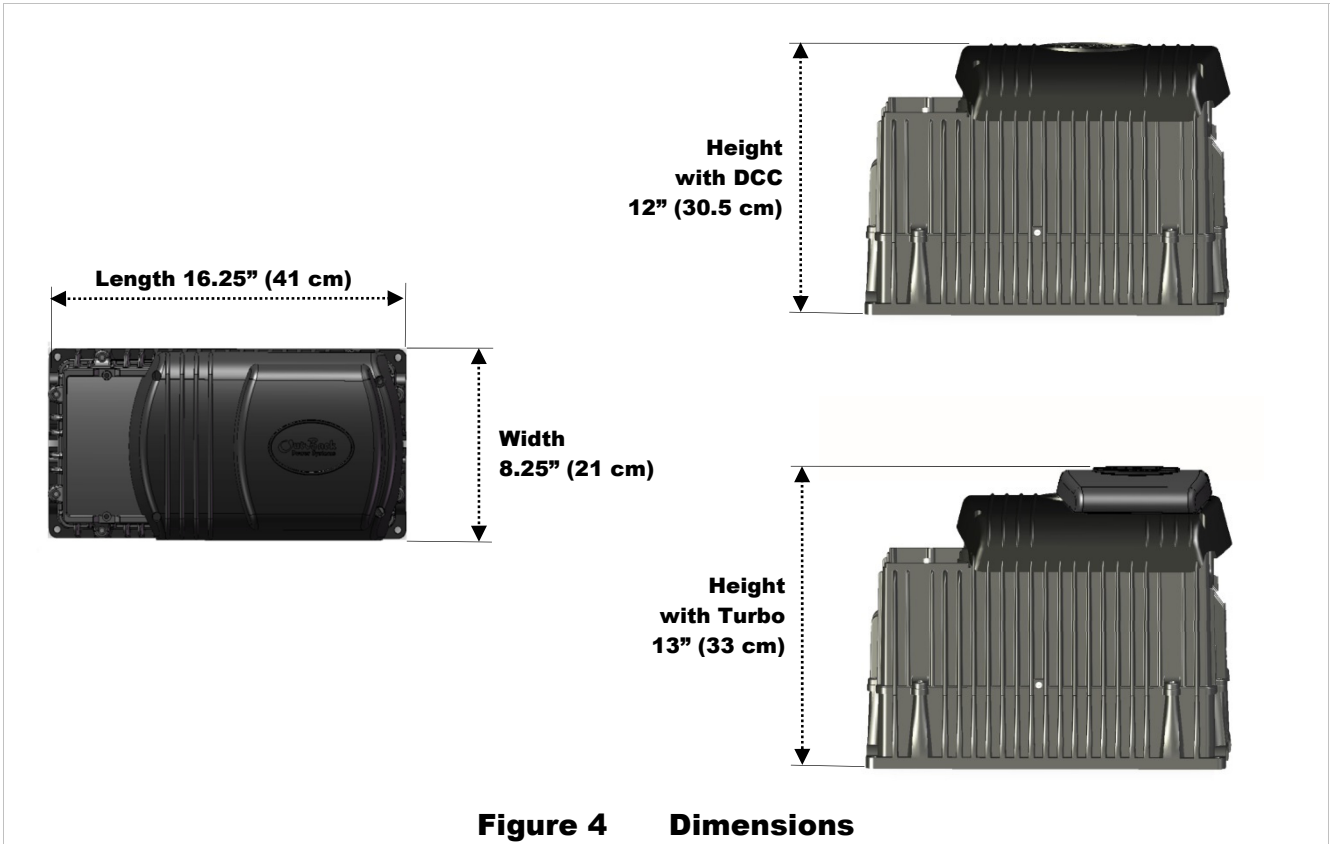



# Terminals and Ports

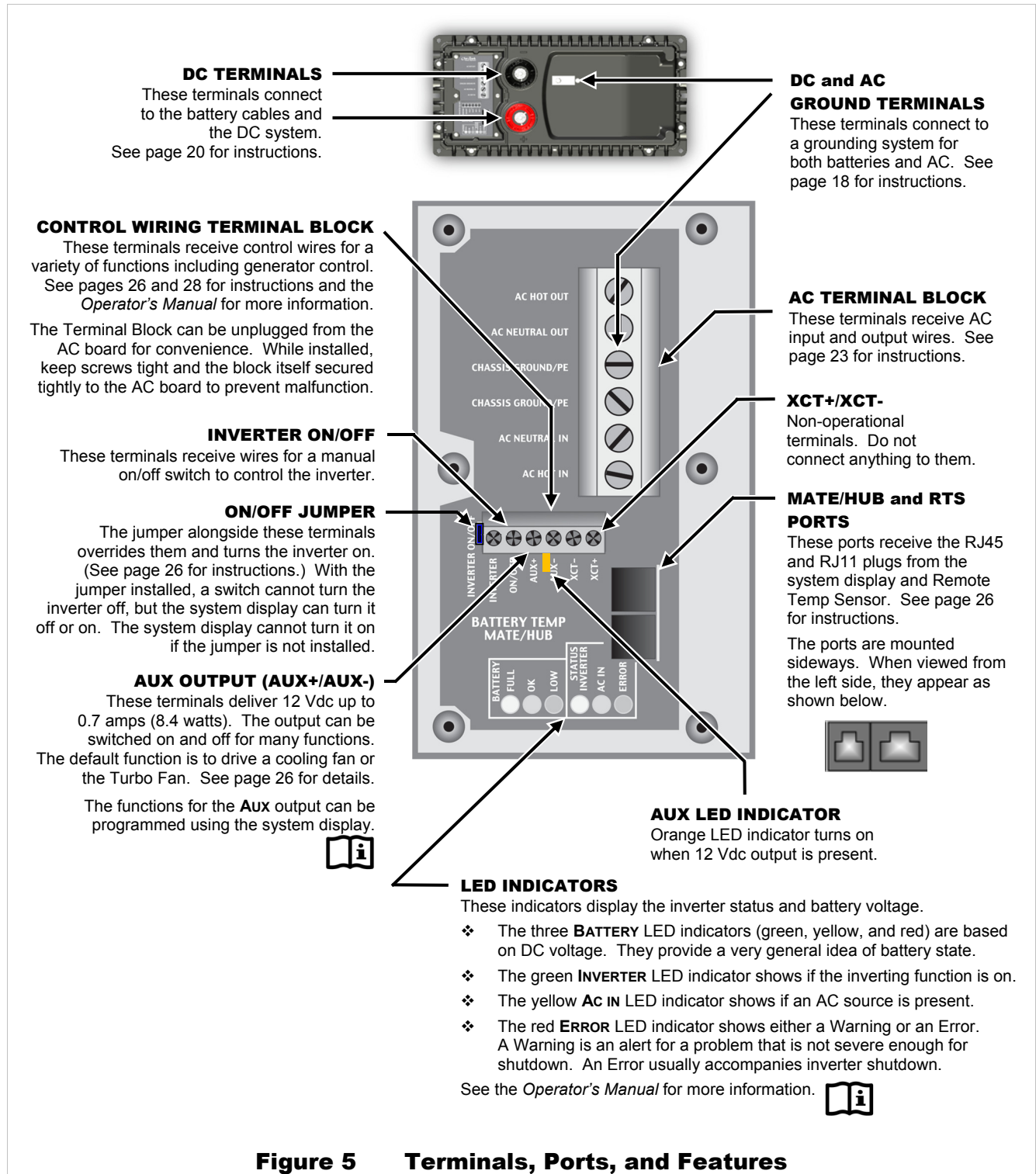

**Figure 5 Terminals, Ports, and Features**



**NOTE:**

The **INVERTER ON/OFF** jumper is installed to the **ON** position during manufacture, but the FXR inverter is given an external **OFF** command at the same time. Its initial state is Off.

## Wiring

It will be necessary to remove knockouts from the AC Plate to run wires. The AC Plate has one knockout of 1/2" size and two knockouts of 3/4" size. Install appropriate bushings to protect the wires.

Use copper wire only. Wire must be rated at 75°C or higher.

## Grounding



	<p><b>WARNING: Shock Hazard</b></p> <ul style="list-style-type: none"> <li>❖ This unit meets the IEC requirements of Protection Class I.</li> <li>❖ The unit must be connected to a permanent wiring system that is grounded according to the IEC 60364 TN standard.</li> <li>❖ The input and output circuits are isolated from ground. The installer is responsible for system grounding according to all applicable codes.</li> <li>❖ For safety, the neutral and ground conductors should be mechanically bonded. OutBack does not bond these conductors within the inverter. Some codes require the bond to be made at the main panel only. Make sure that no more than one bond is present in the AC system at any time.</li> </ul>
	<p><b>WARNING: Shock Hazard</b></p> <p>For all installations, the negative battery conductor should be bonded to the grounding system at only one point. If the OutBack GFDI is present, it provides the bond.</p>
	<p><b>IMPORTANT:</b></p> <p>Most OutBack products are not designed for use in a positive-grounded system. If it is necessary to build a positive-grounded system with OutBack products, see the <b>Positive Grounding</b> applications note at <a href="http://www.outbackpower.com">www.outbackpower.com</a>.</p>

**Table 4 Ground Conductor Size and Torque Requirements**

Terminal Location	Minimum Conductor Size	Torque Requirements
Central AC Terminals	#10 AWG (0.009 in <sup>2</sup> ) or 6 mm <sup>2</sup>	25 in-lb (2.8 Nm)
DC Box Lug	#6 AWG (0.025 in <sup>2</sup> ) or 16 mm <sup>2</sup>	45 in-lb (5.1 Nm)

Table 4 contains OutBack's recommendations for minimum safe cable sizes. Other codes may supersede OutBack's recommendations. Consult applicable codes for final size requirements.

The inverter's DC ground is a box lug located next to the negative DC battery terminal. This lug accepts up to 1/0 AWG (70 mm<sup>2</sup> or 0.109 in<sup>2</sup>) wire. Local codes or regulations may require the DC ground to be run separately from the AC ground. Also, if present, it will be necessary to remove the DC Cover or Turbo Fan before making the ground connection. (See page 22.)

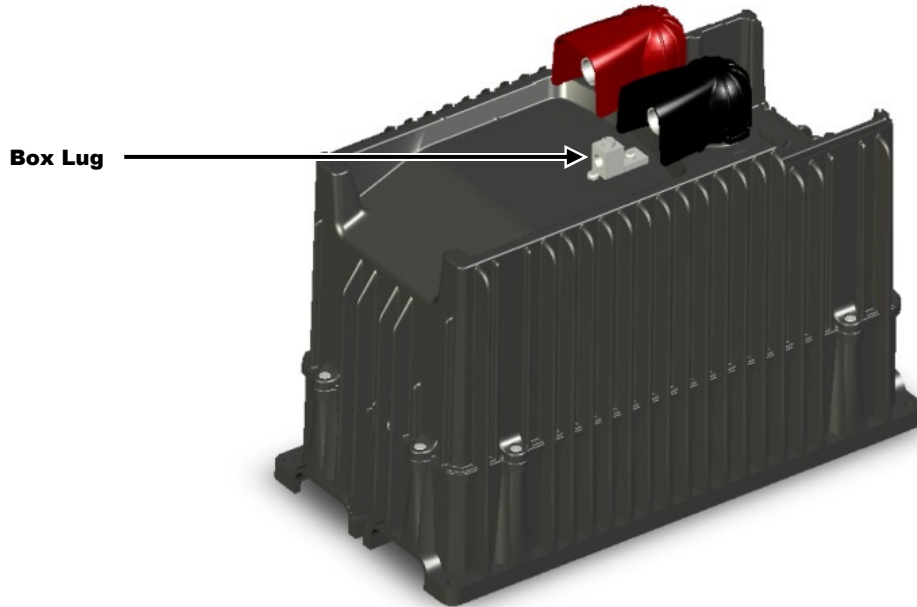

**Figure 6 DC Ground Lug**

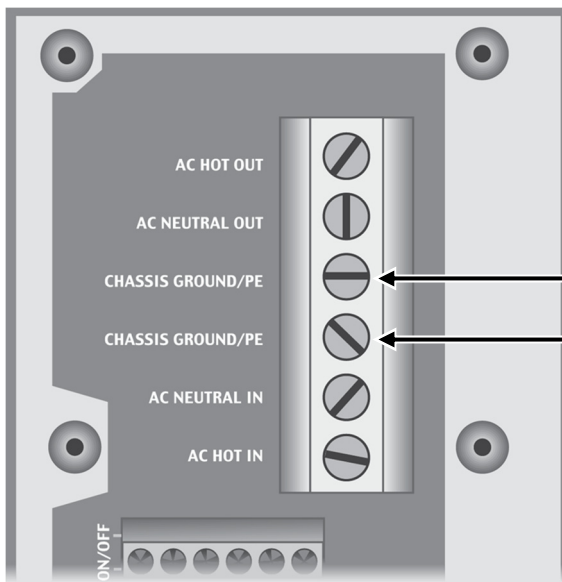





**CHASSIS GROUND/PE**

The two **CHASSIS GROUND/PE** terminals are electrically common. If connecting to an external ground bus, only one terminal needs to be used. The other terminal may be used if connecting to a device with its own ground wire, such as a generator.

**Figure 7 Chassis Ground/PE**

## DC Wiring

	<p><b>WARNING: Shock Hazard</b></p> <p>Use caution when working in the vicinity of the inverter's battery terminals.</p>
	<p><b>CAUTION: Equipment Damage</b></p> <p>Never reverse the polarity of the battery cables. Always ensure correct polarity.</p>
	<p><b>CAUTION: Fire Hazard</b></p> <ul style="list-style-type: none"> <li>❖ The installer is responsible for providing overcurrent protection. Install a circuit breaker or overcurrent device on each DC positive (+) conductor to protect the DC system.</li> <li>❖ Never install extra washers or hardware between the mounting surface and the battery cable lug. The decreased surface area can build up heat. See the hardware diagram on page 21.</li> </ul>
	<p><b>IMPORTANT:</b></p> <ul style="list-style-type: none"> <li>❖ The DC terminals must be encased in an enclosure to meet the requirements of some local or national codes.</li> <li>❖ Table 5 contains OutBack's recommendations for minimum safe cable sizes. Other codes may supersede OutBack's recommendations. Consult applicable codes for final size requirements.</li> </ul>

**Table 5 DC Conductor Size and Torque Requirements**

Inverter	Nominal DC Amps (Minimum, per breaker) (Derated 125%)	Conductor Size <sup>2</sup> (Minimum)	Breaker Size (Minimum)
FXR2012A	200	4/0 AWG (120 mm <sup>2</sup> ) or 0.186 in <sup>2</sup>	250 Adc
VFXR2812A	280	4/0 AWG (120 mm <sup>2</sup> ) or 0.186 in <sup>2</sup>	250 Adc
FXR2524A	125	2/0 AWG (70 mm <sup>2</sup> ) or 0.109 in <sup>2</sup>	175 Adc
VFXR3524A	175	4/0 AWG (120 mm <sup>2</sup> ) or 0.186 in <sup>2</sup>	250 Adc
FXR3048A	75	1/0 AWG (70 mm <sup>2</sup> ) or 0.109 in <sup>2</sup>	125 Adc
VFXR3648A	90	1/0 AWG (70 mm <sup>2</sup> ) or 0.109 in <sup>2</sup>	125 Adc
<b>Terminal Location</b>		<b>Torque Requirements</b>	
Inverter DC Terminals		60 in-lb (6.9 Nm)	
Battery Terminals		See battery manufacturer's recommendations	

### When installing DC cables:

- Battery positive (+) and negative (–) cables should be no longer than 10 feet (3 meters) each. This helps to minimize voltage loss and other possible effects.
- Turn off DC circuit breakers before proceeding.
- Tie, tape, or twist cables together to reduce self-inductance. Run positive and negative cables through the same knockouts and conduit.
- The inverter's battery terminal is a threaded stud which accepts a ring terminal lug. Use crimped and sealed copper ring lugs with 5/16 inch (0.79 cm) holes, or use compression lugs.
- Install all overcurrent devices on the positive cable.

<sup>2</sup> Cable sizes are for each inverter in a system. In a system with multiple inverters, each inverter requires its own cables and overcurrent devices of the size indicated.

## To install DC cables and hardware:

1. Install all DC cables.
2. Do not install hardware in a different order from Figure 8. The battery cable lug should be the first item installed on the stud. It should make solid contact with the mounting surface.
3. Do not close the main DC disconnect until wiring is complete and the system is prepared for commissioning.

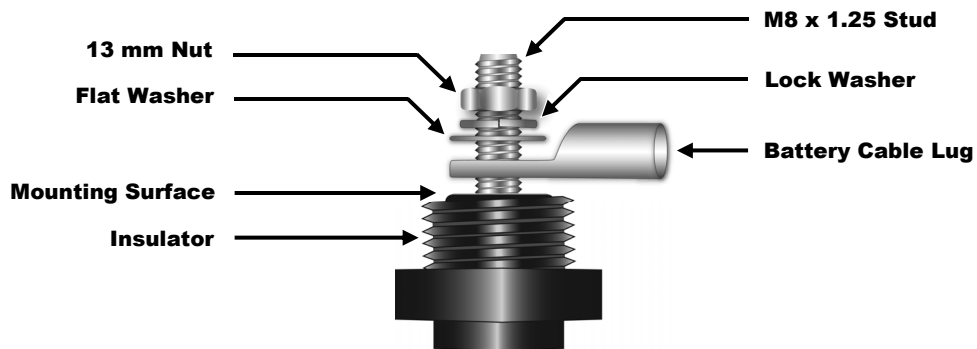

**Figure 8 Required Order of Battery Cable Hardware**



### **CAUTION: Fire Hazard**

Never install extra washers or hardware between the mounting surface and the battery cable lug. The decreased surface area can build up heat.

4. Install the battery terminal covers. These are made of stiff plastic with a snap-on design.

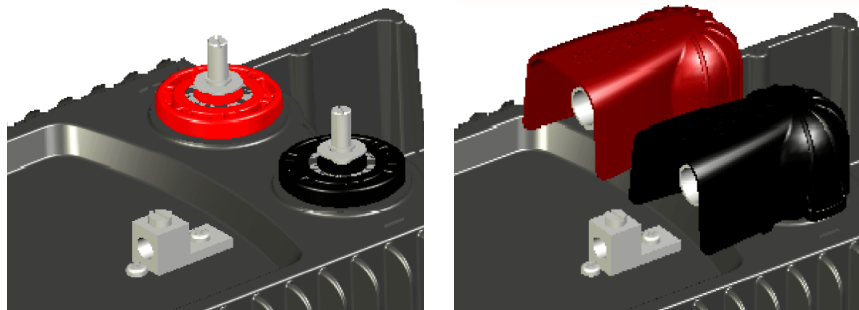

### **REMOVAL SLOT**

If it is necessary to remove the covers, remove carefully using a flat screwdriver. Insert the screwdriver into the slot on the side of each cover and unsnap the cover.

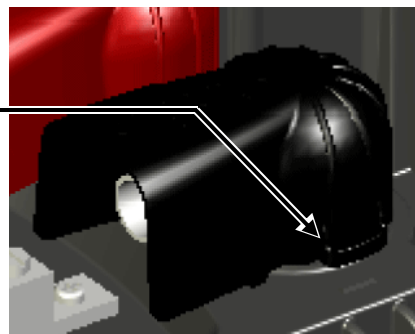

**Figure 9 Battery Terminal Covers**

## DC Cover or Turbo Fan Attachment

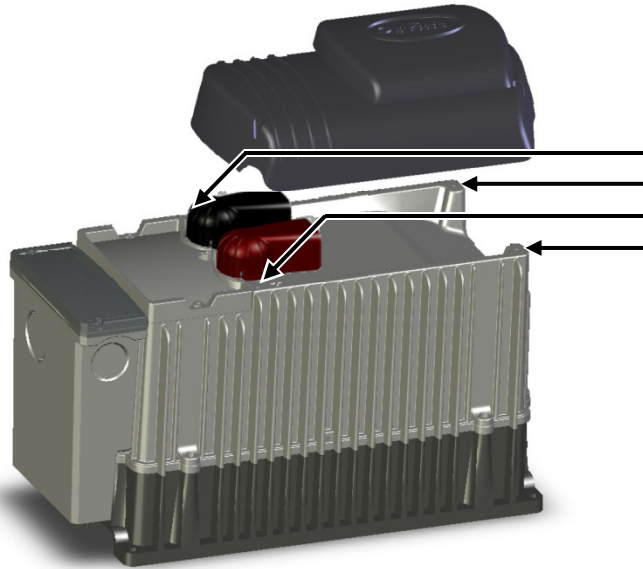

### COVER ATTACHMENT

FXR inverters are equipped with either the DC Cover or the Turbo Fan. To attach either cover, put the cover in place and insert a screw at each corner using a Phillips screwdriver. Make certain the red and black battery terminals are installed before attaching the cover.

As part of attaching the Turbo Fan, follow the wiring instructions in Figure 11.

**Figure 10 DC Cover Attachment**

### TURBO FAN WIRING

Install the wires in the AC Wiring Compartment to make the Turbo Fan operational. The **AUX+** and **AUX-** terminals receive the red (+) and black (-) wires. Tighten with a screwdriver.

To safely run the wires into the AC compartment, pass the wires through the notch in the compartment cover.

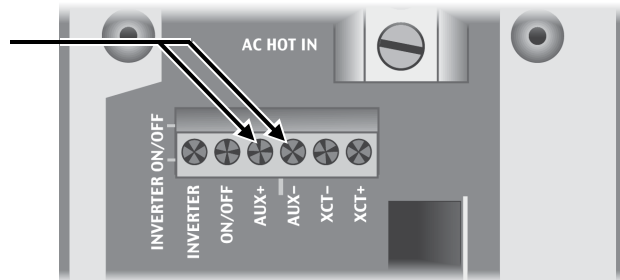

If necessary, the green terminal block can be unplugged by pulling it gently away from the AC board.

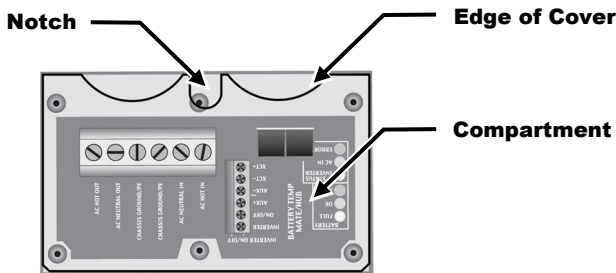





Make certain the **AUX** programming is correct for proper fan operation. 

**Figure 11 Turbo Fan Wiring**

### If it is necessary to remove the Turbo Fan:

1. Remove the screws at the four corners of the Turbo Fan.
2. Remove the compartment cover.
3. Unscrew the **AUX+** and **AUX-** terminal screws.
4. Remove the wires.
5. Remove the Turbo Fan.

# AC Wiring

	<p><b>WARNING: Shock Hazard</b></p> <ul style="list-style-type: none"> <li>❖ The neutral and ground conductors should be mechanically bonded. Ensure there is no more than one AC neutral-ground bond at any time.</li> <li>❖ Local or national codes may require the bond to be made at the main panel only.</li> </ul>
	<p><b>IMPORTANT:</b></p> <ul style="list-style-type: none"> <li>❖ The installer is responsible for providing overcurrent protection. The AC input and output may need to be protected with branch-rated circuit breakers of maximum 60 Aac size to meet applicable code requirements.</li> <li>❖ Applicable codes may prevent grid-interactive inverters from using an input circuit breaker larger than 40 amps. Confirm local requirements before installation.</li> </ul>
	<p><b>WARNING: Fire Hazard</b></p> <p>Do not install these inverters using a load center that has multiwire branch circuits.</p>
	<p><b>IMPORTANT:</b></p> <p>This page contains OutBack's recommendations for minimum safe cable sizes. Other codes may supersede OutBack's recommendations. Consult applicable codes for final size requirements.</p>

All system wiring must comply with national and local codes and regulations.

The FXR inverter's AC terminal block has six positions for AC wires. The terminals will accept conductor sizes up to #6 AWG (16 mm<sup>2</sup>) or 0.021 in<sup>2</sup>.

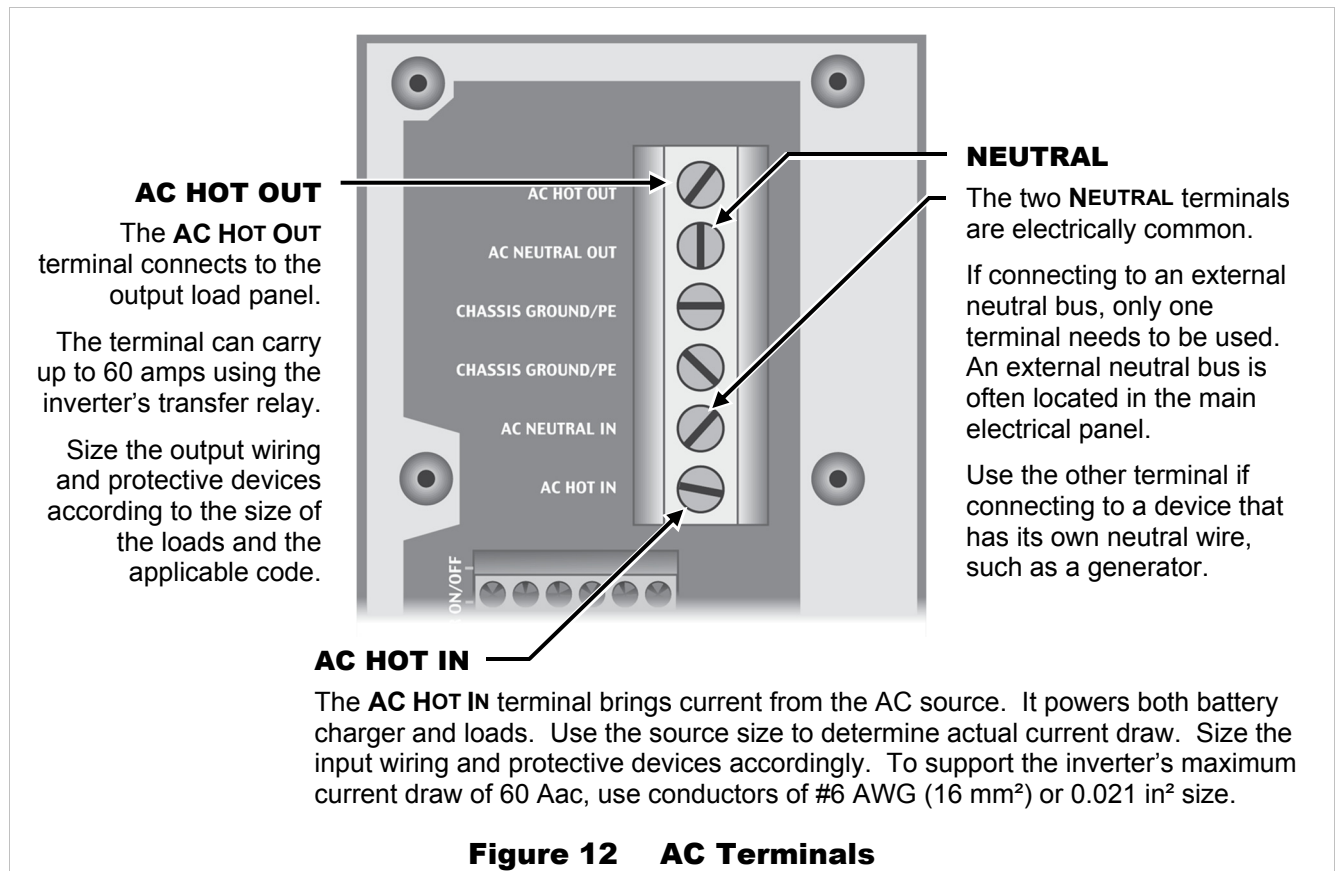

**Figure 12 AC Terminals**

## AC Sources

The inverter has a single set of AC terminals which are intended to connect to a single AC source.

**It cannot be directly wired to more than one AC source at the same time.**

If multiple sources are used, it is usually required to have a selector switch that changes from one to the next. The switch should be the “break before make” type which disconnects from one source before contacting another. This prevents the risk of connecting to two out-of-phase sources at the same time or connecting them to each other.

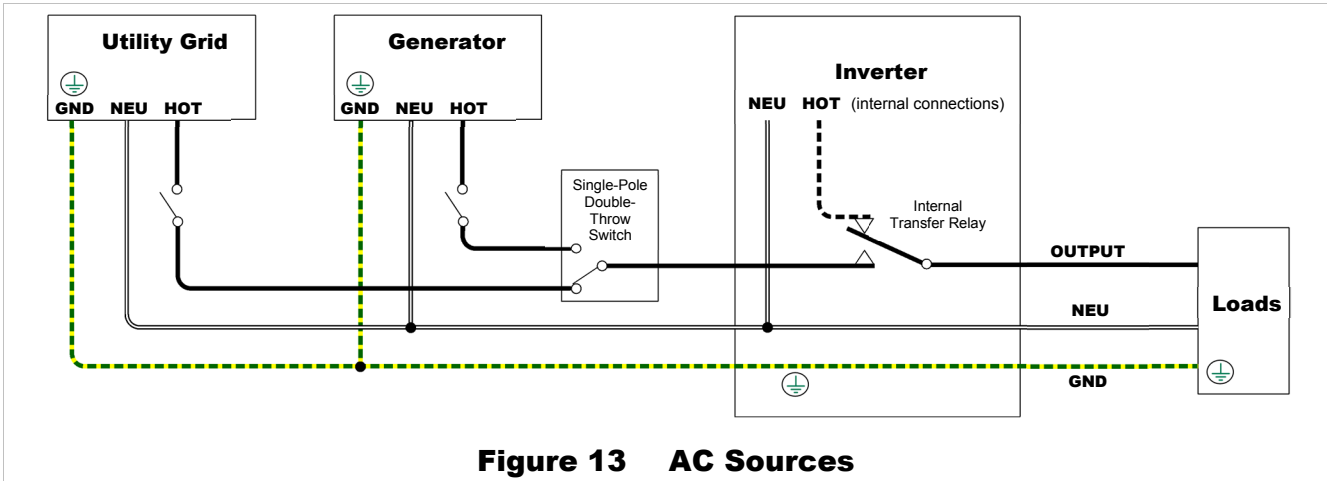

**Figure 13 AC Sources**

The inverter’s transfer relay is normally set to provide inverter power to the output. This is shown in Figure 13, where the internal transfer relay is switched to the inverter function.

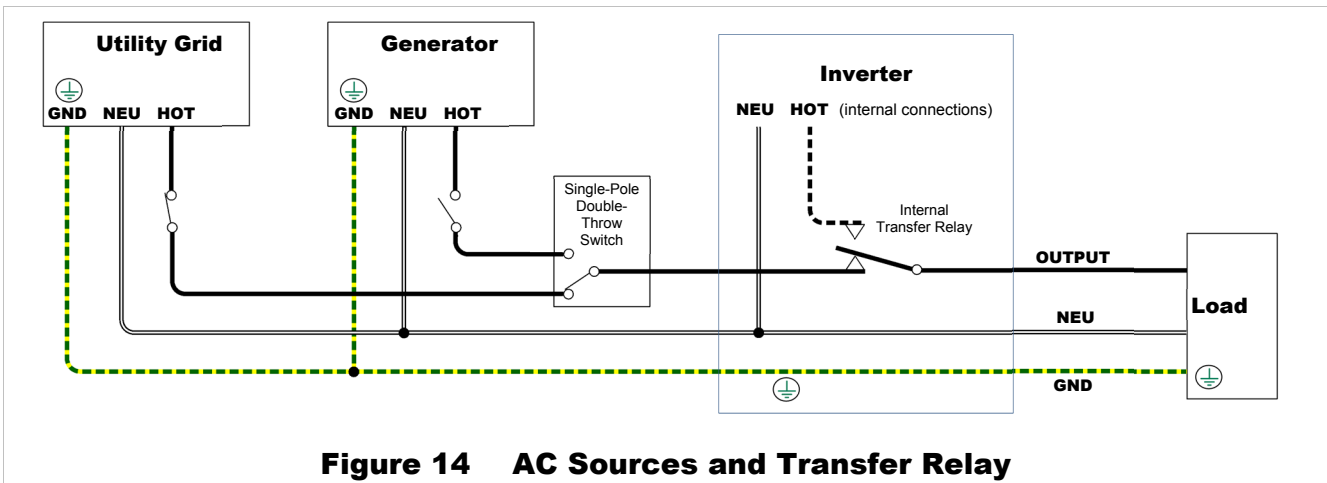

**Figure 14 AC Sources and Transfer Relay**

When an AC source is connected and accepted, the internal transfer relay switches to transfer the AC source power to the loads. Figure 14 shows the utility grid switch closed. The internal transfer relay has switched accordingly so that the loads receive utility power. (See the *Operator’s Manual* for the inverter’s acceptance criteria.)



**NOTE:**

The use of a GFCI-equipped AC source to power either the **GRID** or **GEN** input is not recommended.



## ON and OFF Wiring

The **INVERTER ON/OFF** jumper bridges two pins. This jumper parallels the two **INVERTER ON/OFF** terminals on the Control Wiring Terminal Block. If either connection is closed, this sets the inverter to On as long as the internal programming has not been set to Off with the system display. (The inverter is given an external **OFF** command in the factory. Its initial state will be Off.)

An inverter in the Off state will not invert. However, it may still transfer power to loads and charge batteries from an AC source.

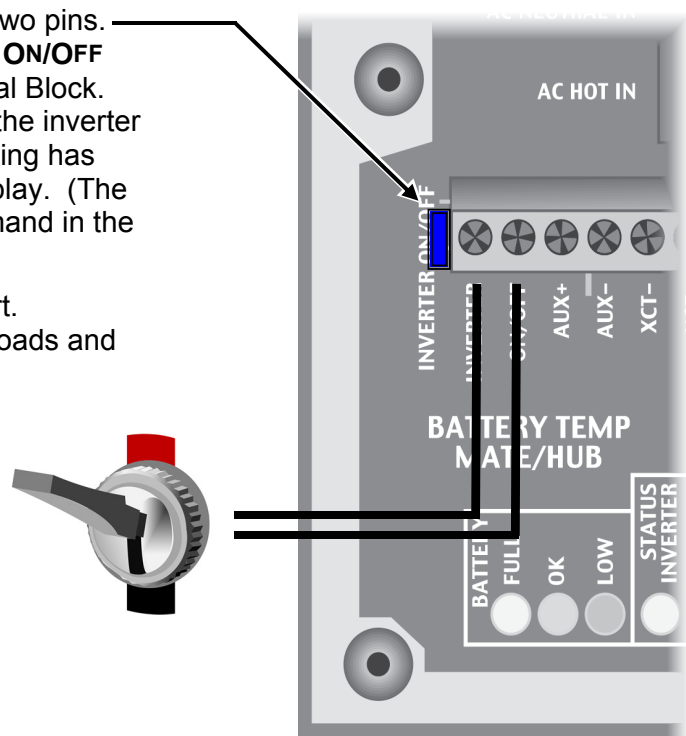

**Jumper Off**

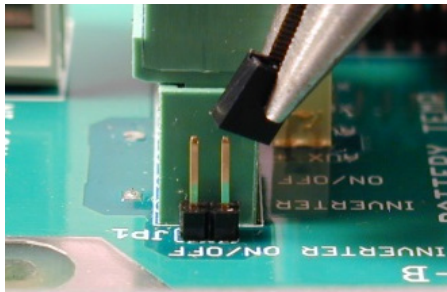

**Jumper On**

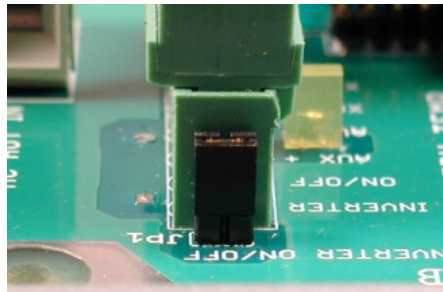

### **If the system display is not present:**

To turn the inverter initially On, remove the jumper briefly and then replace it. This requires long-nose pliers or a similar tool. (This will change the internal programmed state to On.) After this, removing the jumper will immediately turn the inverter Off.

Once the jumper has been removed, the **INVERTER ON/OFF** terminals on the Control Wiring Terminal Block can be used to wire a manual on/off switch or an emergency shutoff.

**Figure 15 ON/OFF Jumper and Connections**

## Accessory Wiring

The AC Wiring Compartment Board has ports for both the Remote Temperature Sensor (RTS) and the system display. The system display port is labeled **MATE/HUB**.

**RTS cable**  
(RJ11, 4-conductor, telephone)



**System Display cable**  
(RJ45, 8-conductor, CAT5 non-crossover)

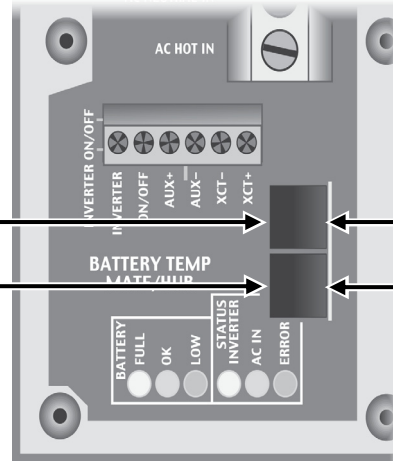

**RTS port**

**MATE/HUB port**  
See the *Operator's Manual* for more information on the RTS.



**Additional ports**

**MATE port**

If a HUB Communications Manager is used, it occupies the inverter's **MATE/HUB** port. The system display plugs into the HUB product.

Inverters plug into ports 1 and above. Charge controllers and other devices plug into unassigned ports not used by inverters.

See **Stacking** on page 31 for information on connecting inverters. See the HUB product literature for other devices.



**NOTE:**

When first installing cables on the **BATTERY TEMP** and **MATE/HUB** ports, make certain to apply silicone grease to the connections. A packet is provided with the inverter.

**Figure 16 Accessory Connections**

## AUX Wiring

The **AUX+** and **AUX-** terminals are a switched 12 Vdc supply. The **AUX** can respond to different criteria and control many functions. These include cooling fans, vent fans, load diversion, fault alarms, and the **Advanced Generator Start** (AGS) function.

The terminals can supply up to 0.7 amps at 12 Vdc (8.4 watts). This is sufficient to drive a small fan or a relay controlling a larger device. The terminals accept wire up to #14 AWG (2.5 mm<sup>2</sup>). The **AUX** circuit contains electronic overcurrent protection, which resets after being overloaded. No additional fuses are required for the **AUX** terminals.

The default setting for the **AUX** output is to control the Turbo Fan included with sealed models. (See Figure 17.) The **AUX** output can only control one function at a time. It cannot be used for anything else if the Turbo Fan is connected.

The control logic for the **AUX** output may be located in the inverter or it may be in the system display or another location. FXR **AUX** functions are located in the inverter and are described accordingly. Although inverter-based functions require the system display for programming, they will function even if it is removed. However, AGS programming is located within the system display even though it uses the FXR **AUX** terminals. It will not work if the display is removed. (Other devices may also be able to control the terminals.) For generator control, see page 28.

In this example, the **AUX** directly drives a 12-volt vent fan. The + and – wires on the fan are connected to the **AUX+** and **AUX–** terminals.

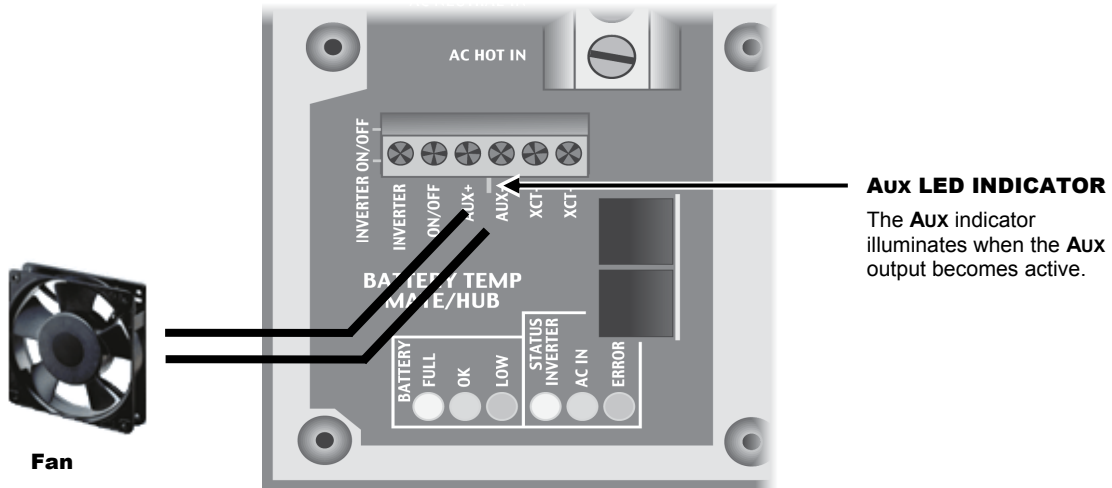

**Figure 17 AUX Connections for Vent Fan (Example)**

In this example, the **AUX** output drives a relay that diverts wind power. The relay's coil is connected to the **AUX+** and **AUX–** terminals. When the **AUX** output closes the relay (based on battery voltage), the relay diverts the excess wind power to a water heating element.

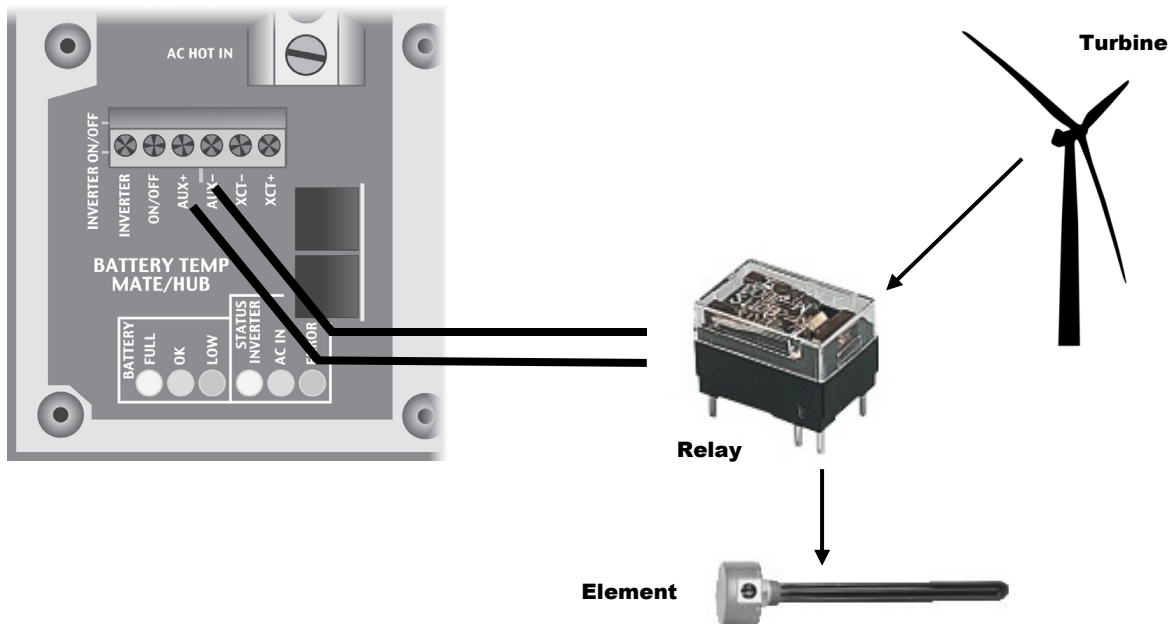

**NOTE:** Relays and elements shown are examples only and may vary depending on the installation.

**Figure 18 AUX Connections for Diversion (Example)**

## Generator Control

The **AUX** terminals can provide a signal to control an automatic-start generator. The control function can be **Advanced Generator Start (AGS)**, which is situated in the system display. AGS can start the generator using settings from the system display, or it can use battery readings from the FLEXnet DC battery monitor. Note that AGS cannot be used if the system display is removed.

Alternately, the control function can be **Gen Alert**, which is a simpler function based directly in the FXR inverter. The choice of function depends on system needs and the capabilities of each device.

The generator must be an electric-start model with automatic choke. It is recommended to have “two-wire” start capability. A two-wire-start generator is the simplest type, where the cranking and starting routine is automated. It usually has a single switch with two positions that is turned **ON** to start, **OFF** to stop.

## Two-Wire Start

The 12 Vdc signal provided by the **AUX** output can be switched on and off to provide a start signal. It is possible to send a 12-Vdc signal directly to the generator. However, this should never be done if it connects the **AUX** output directly to the generator’s own battery. It is more common to use the **AUX** terminals to energize the coil of a 12 Vdc automotive or similar relay.

The OutBack FLEXware Relay Assembly depicted in Figure 19 is sold for this purpose. The relay contacts can serve in place of the generator’s start switch. The battery shown below (①) is depicted for clarity. In most cases the battery is part of the generator’s internal starting circuit and is not an external component.

The drawing below is one example of a possible arrangement. Specific arrangements, relays, and other elements depend on the requirements of the installation and of the generator.

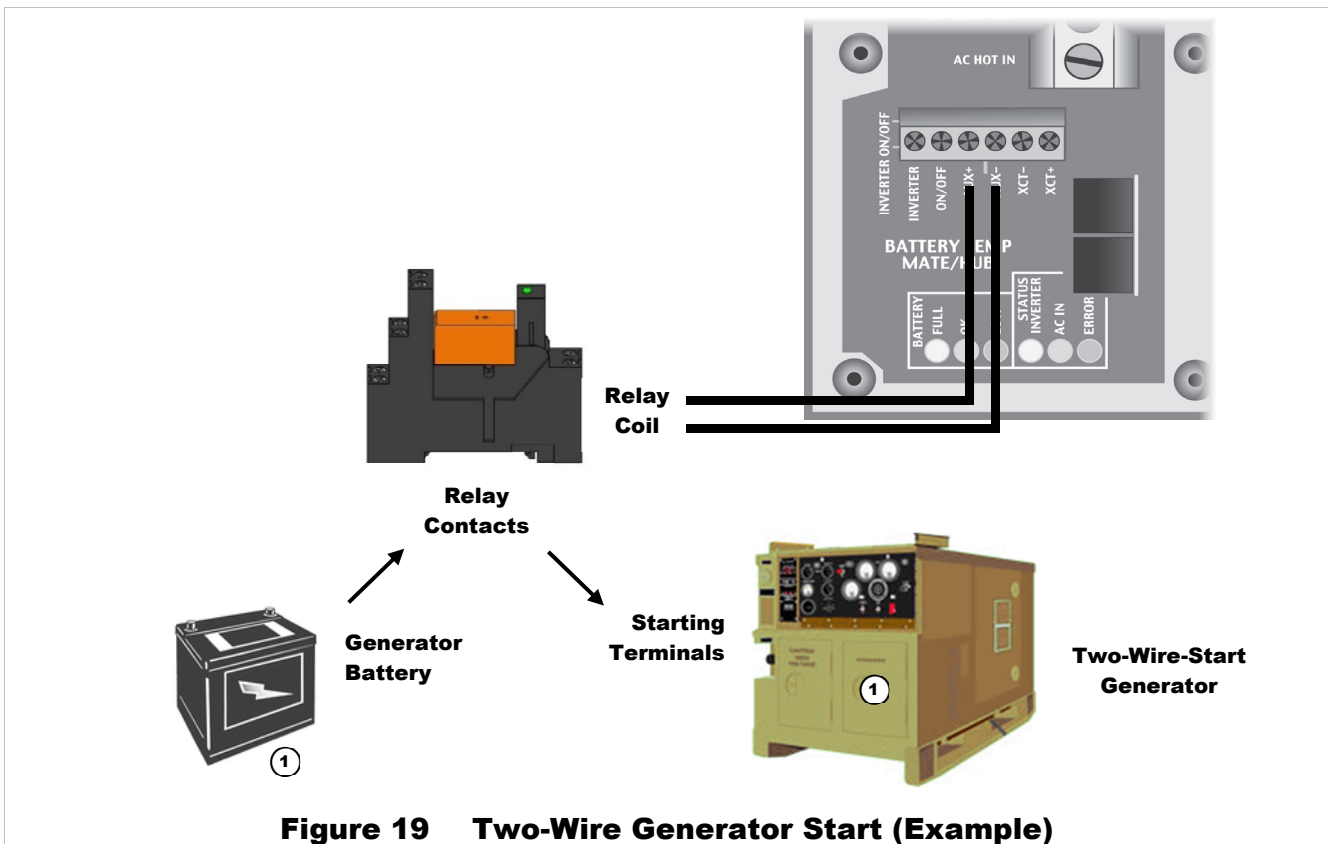

**Figure 19 Two-Wire Generator Start (Example)**

## Three-Wire Start

A “three-wire-start” generator has two or more starting circuits. It usually has a separate switch or position for cranking the generator. A generator with three-wire start has fewer automated functions than a two-wire-start generator. It usually requires multiple controls for starting, running, or stopping. The **AUX** terminals cannot control this type of generator without using a three-wire to two-wire conversion kit.

Atkinson Electronics (<http://atkinsonelectronics.com>) is one company that makes these kits. The Atkinson GSCM-Mini is intended to work with OutBack inverters.

The drawing below is one example of a possible arrangement. Specific arrangements, relays, and other elements depend on the requirements of the installation and of the generator.

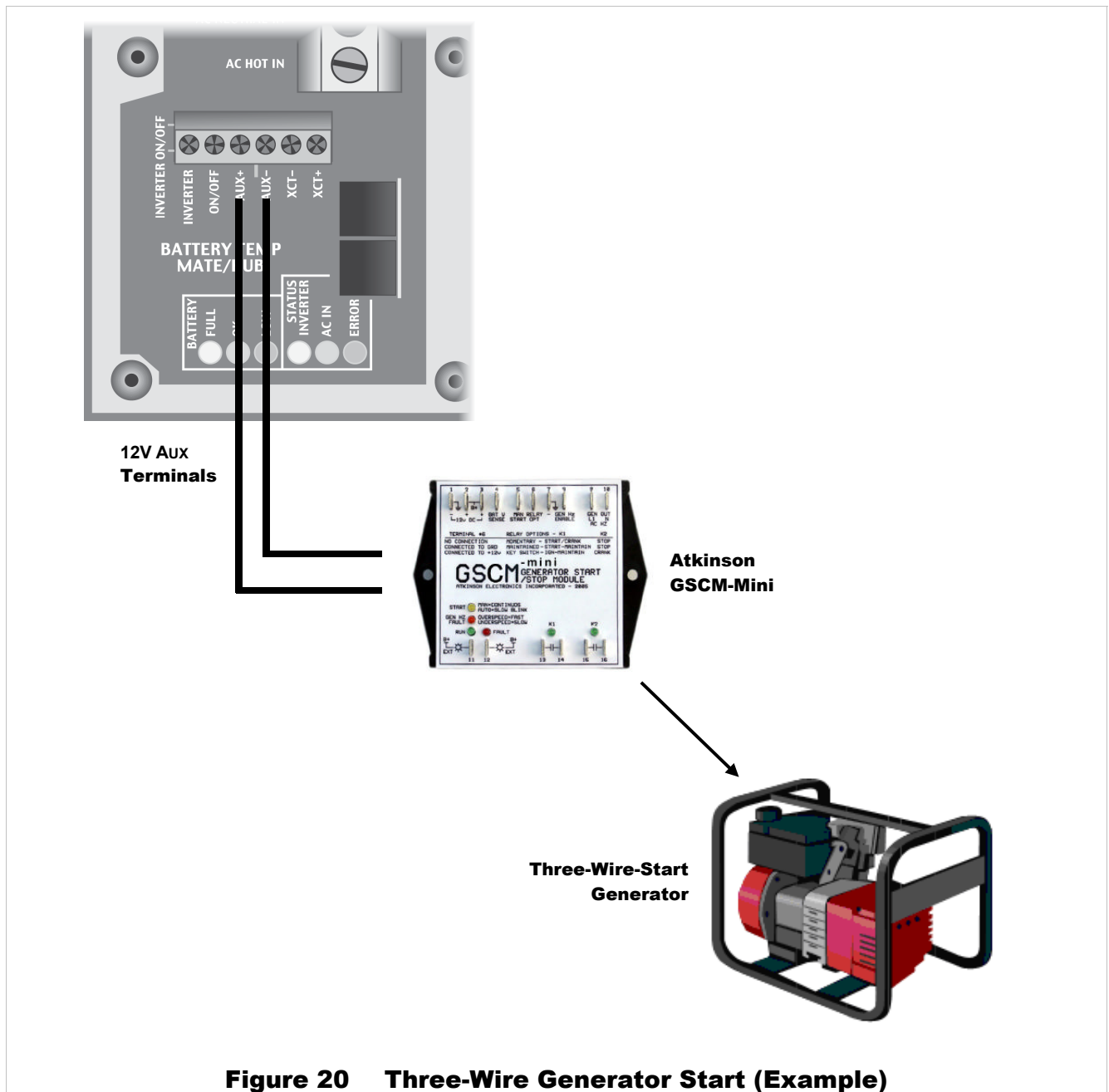

**Figure 20 Three-Wire Generator Start (Example)**

## AC Configurations

### Single-Inverter

When installing an inverter AC system, the following rules must be observed.

- All overcurrent devices must be sized for 60 Aac or less.
- All output wiring and circuit breakers must be sized appropriately for loads and inverter power.
- The AC input (generator or utility grid) must be single-phase and the proper voltage and frequency.

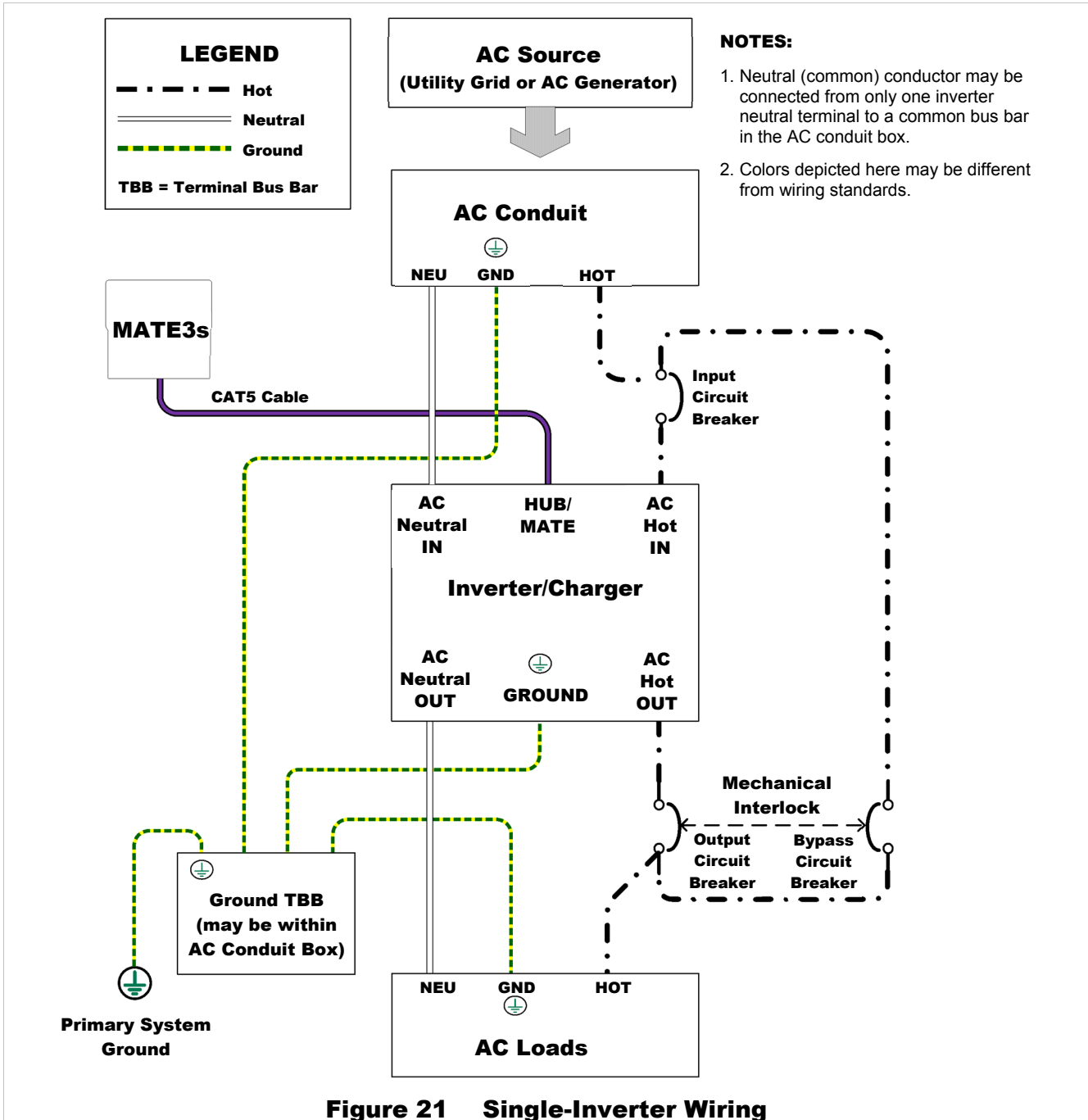

## Multiple-Inverter AC Installations (Stacking)

Installing multiple inverters in a single AC system allows larger loads than a single inverter can handle. This requires “stacking”. Stacking inverters refers to how they are wired within the system and then programmed to coordinate activity. Stacking allows all units to work together as a single system.

Examples of stacking configurations include “series”, “parallel”, “series/parallel”, and “three-phase”.

### Stacking Connections

Stacking requires an OutBack HUB10.3 communications manager and a system display. Make all interconnections between the products with CAT5 non-crossover cable.

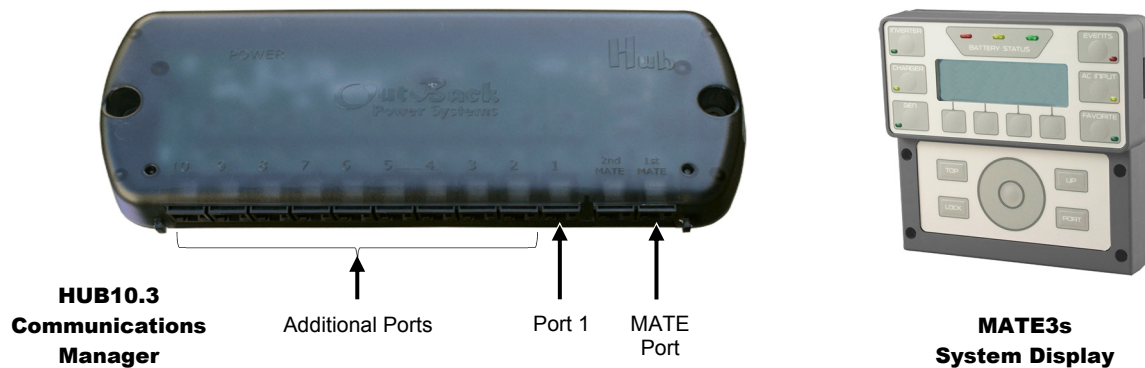

**Figure 22 OutBack Communications Manager and System Display**

Each inverter must be assigned a stacking mode, “master” or “slave” of some type depending on the configuration.

- The master inverter provides the primary output phase, L1 (or Phase A in a three-phase system). Other inverters in the system base their phase on that of the master inverter. If the master shuts off, all other inverters also shut off. The master must sense and connect to an AC source before other inverters can connect.
  - ~ In a parallel-stacked system, the master tends to be the most heavily used unit.
  - ~ “Subphase master” inverters are used to control other phases in series or three-phase systems. A subphase master inverter operates semi-independently of the master inverter. Although the master inverter sets the phase relationship, the subphase master creates an output independent of the master.
  - ~ The master on the L1 (or A phase) output cannot measure loads and voltages on any other output. The subphase masters for each of the other outputs perform monitoring and regulation for the phase they control.
  - ~ In a series or series/parallel-stacked system, a subphase master is required for the L2 output.
  - ~ In a three-phase system, subphase masters are required for both the B and C phases.
- A slave inverter does not create an independent output. It simply assists the master or subphase master by adding power to the output as needed.
  - ~ The Power Save function can place slave inverters in “Silent” mode when not in use. They are activated by the master or subphase master when required.



**NOTE:**

The FW-X240 and similar transformers are not used for load balancing of stacked FXR inverters.

## Installation

Each inverter is assigned to a particular phase when assigned a port on the HUB10.3 communications manager. Port assignments will vary with the system. The master must be plugged into port 1. In parallel stacking, any slave inverter can use any other port, beginning with port 2. In series or three-phase stacking, the port assignments are very specific. See the HUB10.3 literature for more information. Regardless, it is important to keep track of units and ports for programming purposes.

Programming uses the system display to assign a status and stacking value to the inverter on each port. As long as the master is plugged into port 1, these assignments can be changed as needed.



### IMPORTANT:

- ❖ The master inverter must always be connected to port 1 on the communications manager. Connecting it elsewhere, or connecting a slave to port 1, will result in backfeed or output voltage errors which will shut the system down immediately.
- ❖ All stacked FXR inverters must have the same firmware revision. If inverters are stacked with different firmware revisions, any unit with a revision different from the master will not function. The system display will display the following message:  
**An inverter firmware mismatch has been detected. Inverters X, Y, Z<sup>3</sup> are disabled. Visit [www.outbackpower.com](http://www.outbackpower.com) for current inverter firmware.**
- ❖ FXR-class inverters cannot be stacked with FX-class inverters. If more than one model class or series is stacked, any inverter different from the master will not invert or connect to an AC source. The system display will register an Event in the log. It will display the following message:  
**A model mismatch has been detected. Inverters are incompatible. Inverters X, Y, Z<sup>3</sup> are disabled. Match all models before proceeding.**
- ❖ Installing multiple inverters without stacking them (or stacking them incorrectly) will result in similar errors and shutdown.
- ❖ Although stacking allows greater capacity, the loads, wiring, and overcurrent devices must still be sized appropriately. Overloading may cause circuit breakers to open or the inverters to shut down.
- ❖ An AC source should provide input to all inverters on all phases.

<sup>3</sup> The port designations for the mismatched inverters are listed here.



## Stacking Configurations

### Series Stacking (Dual-Stack)

In series stacking, two inverters create two separate 120 Vac<sup>4</sup> output phases. One phase is the master. The second inverter is a subphase master. It creates a 120 Vac output that is intentionally 180° out of phase with the master. Each of these outputs can be used to power a separate set of 120 Vac loads. Collectively they form a “split-phase” configuration. This configuration produces 240 Vac, which can be used to power 240 Vac loads when both inverters work together.

- The two outputs operate independently of each other. The 120 Vac loads on each output cannot exceed a given inverter’s size. One inverter cannot assist on the opposite phase.
- Both inverters must be the same model.
- See page 37 when stacking in series with more than two inverters (series/parallel stacking).

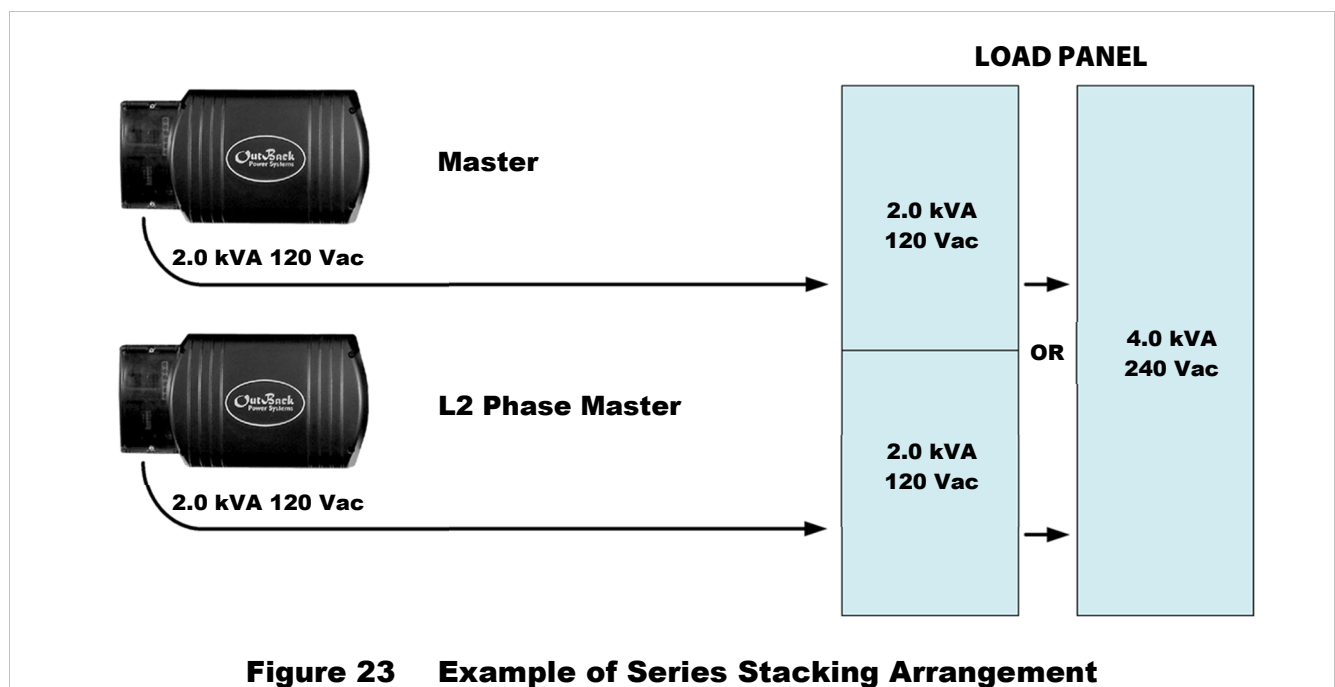

When installing a series inverter system, observe the following rules.

- Series stacking requires both the system display and the communications manager. See the HUB10.3 literature for any required jumper configurations.
- The master must be connected to communications manager port 1. It is programmed as **Master**.  Other inverters must not be assigned as the master.
- The second inverter must be programmed as **L2 Phase Master**. It must be connected to port 7.
- All wiring and circuit breakers must be sized appropriately for loads and inverter power.
- The AC input (generator or utility grid) must be a split-phase source of the proper voltage and frequency.
- When wiring the AC source to the inverters, local codes may require the inverter circuit breakers to be located at the bottom of the main panel. This prevents overloading of the AC bus.

**NOTE:** The FW-X240 and similar transformers are not used for load balancing of stacked FXR inverters.

<sup>4</sup> Output voltages may vary with regional voltage standards.  
900-0166-01-01 Rev A

# Installation

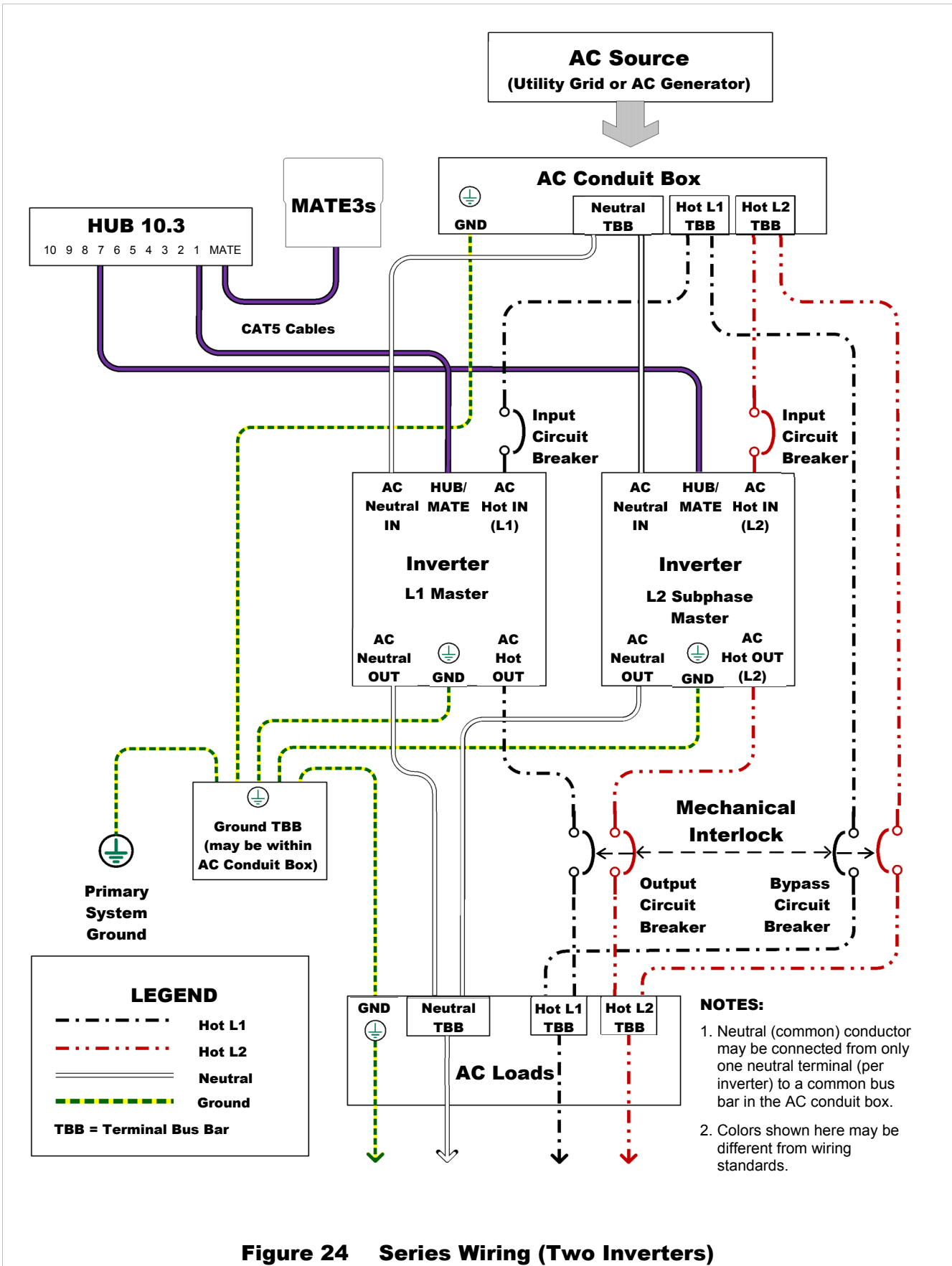
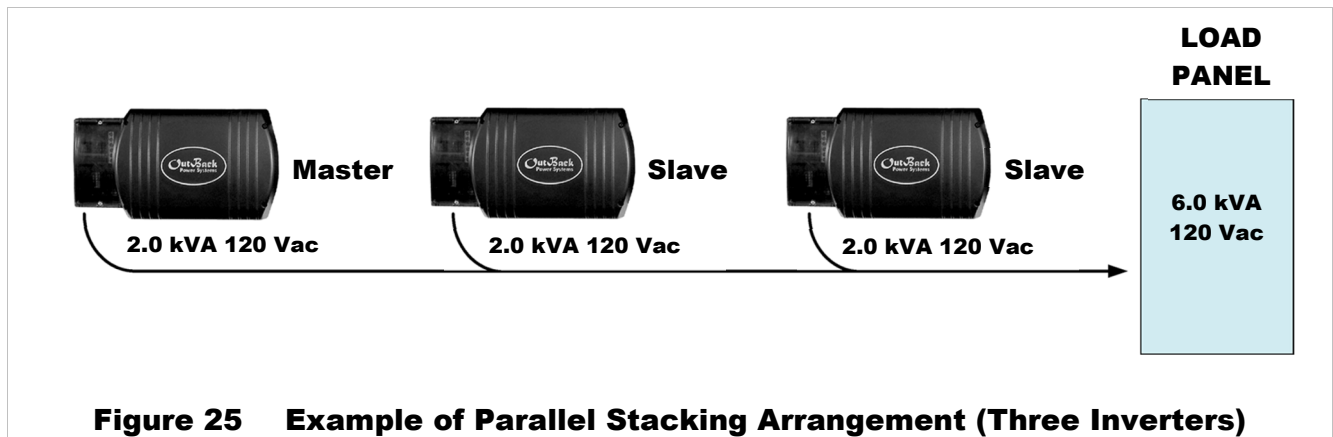

**Figure 24 Series Wiring (Two Inverters)**

## Parallel Stacking (Dual-Stack and Larger)

In parallel stacking, two or more inverters create a single, common 120 Vac<sup>5</sup> bus.

- The slave outputs are controlled directly by the master and cannot operate independently.
- All inverters share a common input (AC source) and run loads on a common output.
- Slave inverters can go into Silent mode when not in use. The master will activate individual slaves based on load demand. This reduces idle power consumption and improves system efficiency.
- Up to ten inverters may be installed in a parallel arrangement. The example on this page shows three inverters. The wiring diagram on the next page shows four. All inverters must be the same model.



**Figure 25 Example of Parallel Stacking Arrangement (Three Inverters)**

When installing a parallel inverter system, observe the following rules.

- Parallel stacking requires both the system display and the communications manager. See the HUB10.3 literature for any required jumper configurations.
- The inverter that is mounted physically lowest is always the master and is programmed as **Master**.  Mounting below the other inverters allows the master to avoid heat buildup and remain relatively cool as it sees the greatest duty cycle.
- The master must be connected to port 1 of the communications manager. Other inverters must not be assigned as master.
- All slave inverters, regardless of number, should be assigned as **Slave** during programming. Slaves can be connected to any port numbered 2 and above.
- All wiring and circuit breakers must be sized appropriately for loads and inverter power.
- The AC input (generator or utility grid) must be a single-phase source of the proper voltage and frequency.
- When wiring the AC source to the inverters, local codes may require the inverter circuits to be located at the opposite end of the panel from the main circuit breaker. This prevents overloading of the AC bus.

<sup>5</sup> Output voltages may vary with regional voltage standards.  
900-0166-01-01 Rev A

# Installation

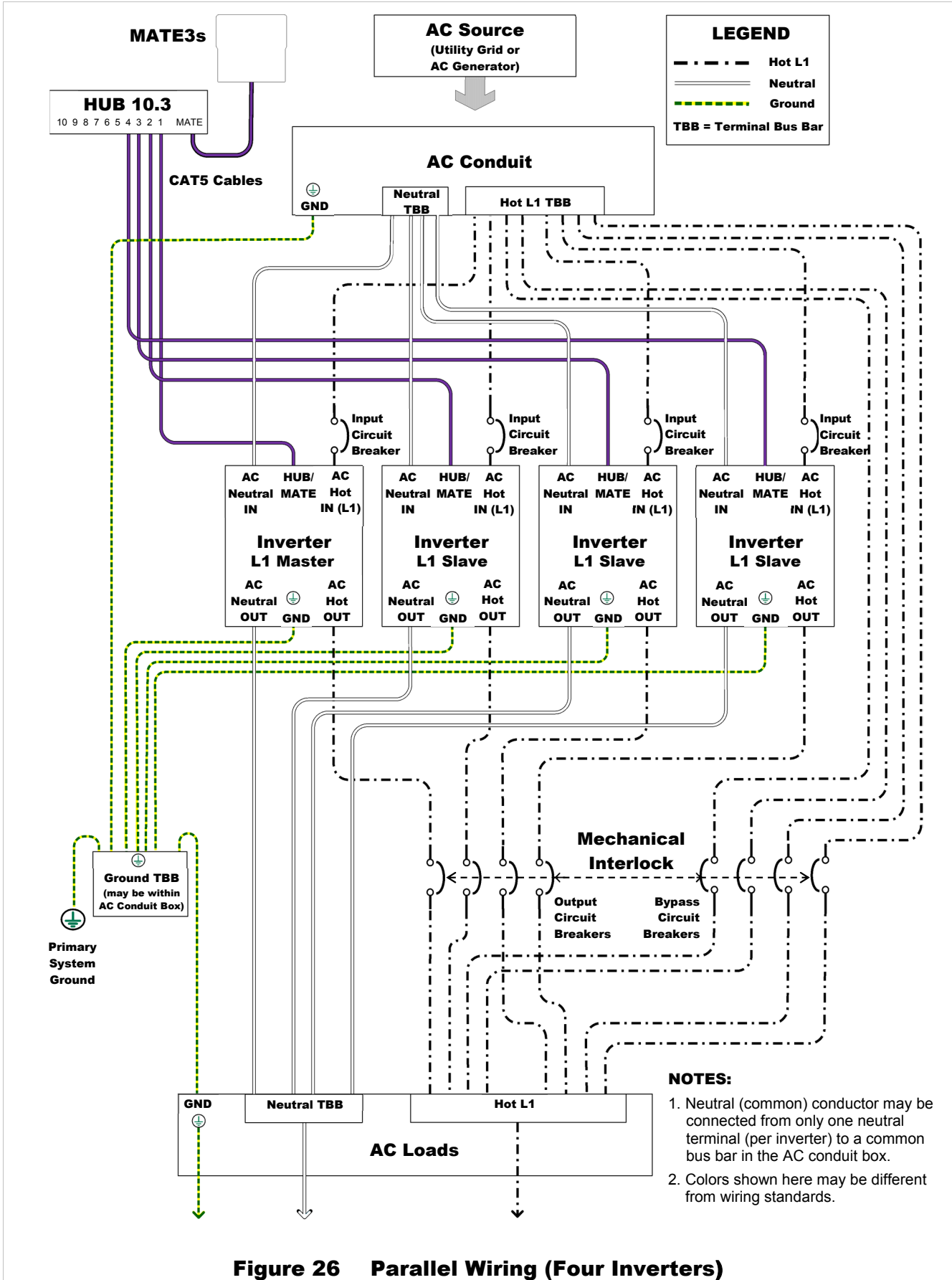
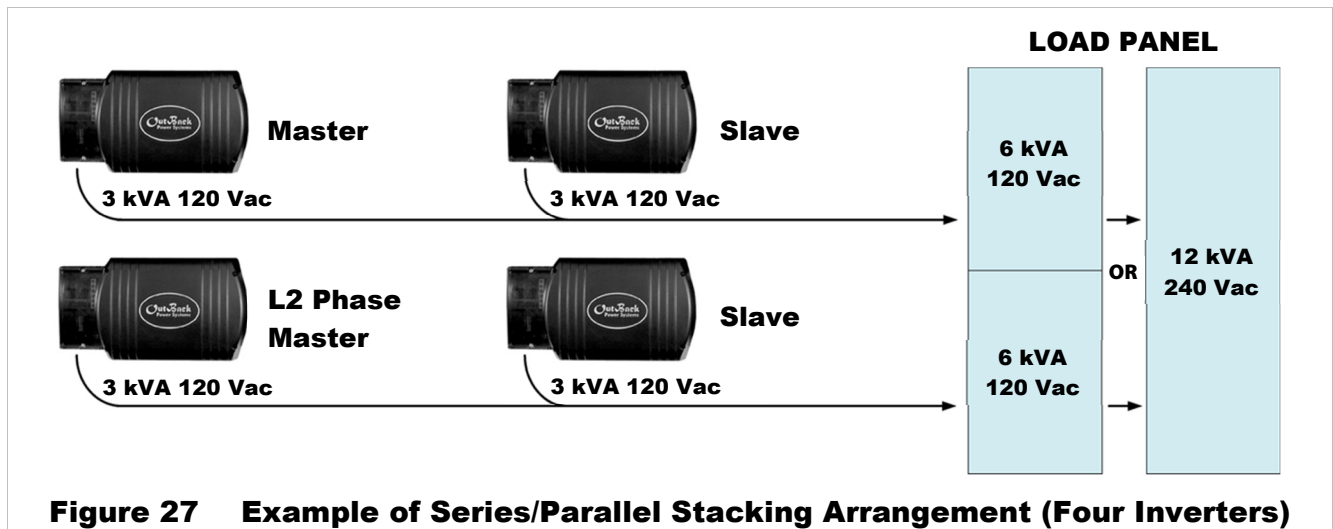

**Figure 26 Parallel Wiring (Four Inverters)**

## Series/Parallel Stacking (Quad-Stack or Larger)

In series/parallel stacking, inverters create separate 120 Vac<sup>6</sup> output phases and 240 Vac collectively, as in series stacking. However, in this configuration, each output uses inverters in parallel. One output contains the master; the other uses a subphase master. Each output has at least one slave.

- The 120 Vac loads on each output can exceed the size of a single inverter. They can be powered by all the inverters on that output.
- The slave outputs are controlled directly by their respective master inverters. They cannot operate independently. The slaves can go into Silent mode when not in use.
- Up to eight inverters may be installed in series/parallel. All inverters must be the same model.



**Figure 27 Example of Series/Parallel Stacking Arrangement (Four Inverters)**

When installing a multiple-inverter series/parallel system, observe the following rules.

- Series/parallel stacking requires both the system display and the communications manager. See the HUB10.3 literature for any required jumper configurations.
- The inverter that is mounted physically lowest is always master and is programmed as **Master**.  Mounting below the other inverters allows the master to avoid heat buildup and remain relatively cool as it sees the greatest duty cycle.
- The master must be connected to port 1 of the communications manager. Other inverters must not be assigned as master.
- Any other inverter on the L1 output (parallel with the master) should be assigned as **Slave** during programming. These can be connected to ports 2 through 4. L1 inverters cannot use other ports.
- The subphase master for the L2 output must be assigned as **L2 Phase Master**. It must be connected to port 7.
- Any other inverter on the L2 output (parallel with the subphase master) should be assigned as **Slave** during programming. These can be connected to ports 8 through 10. L2 inverters cannot use other ports.
- All wiring and circuit breakers must be sized appropriately for loads and inverter power.
- The AC input (generator or utility grid) must be a split-phase source of the proper voltage and frequency.
- When wiring the AC source to the inverters, local codes may require the inverter circuits to be located at the opposite end of the panel from the main circuit breaker. This prevents overloading of the AC bus.

**NOTE:** The FW-X240 and similar transformers are not used for load balancing of stacked FXR inverters.

<sup>6</sup> Output voltages may vary with regional voltage standards.  
900-0166-01-01 Rev A

# Installation

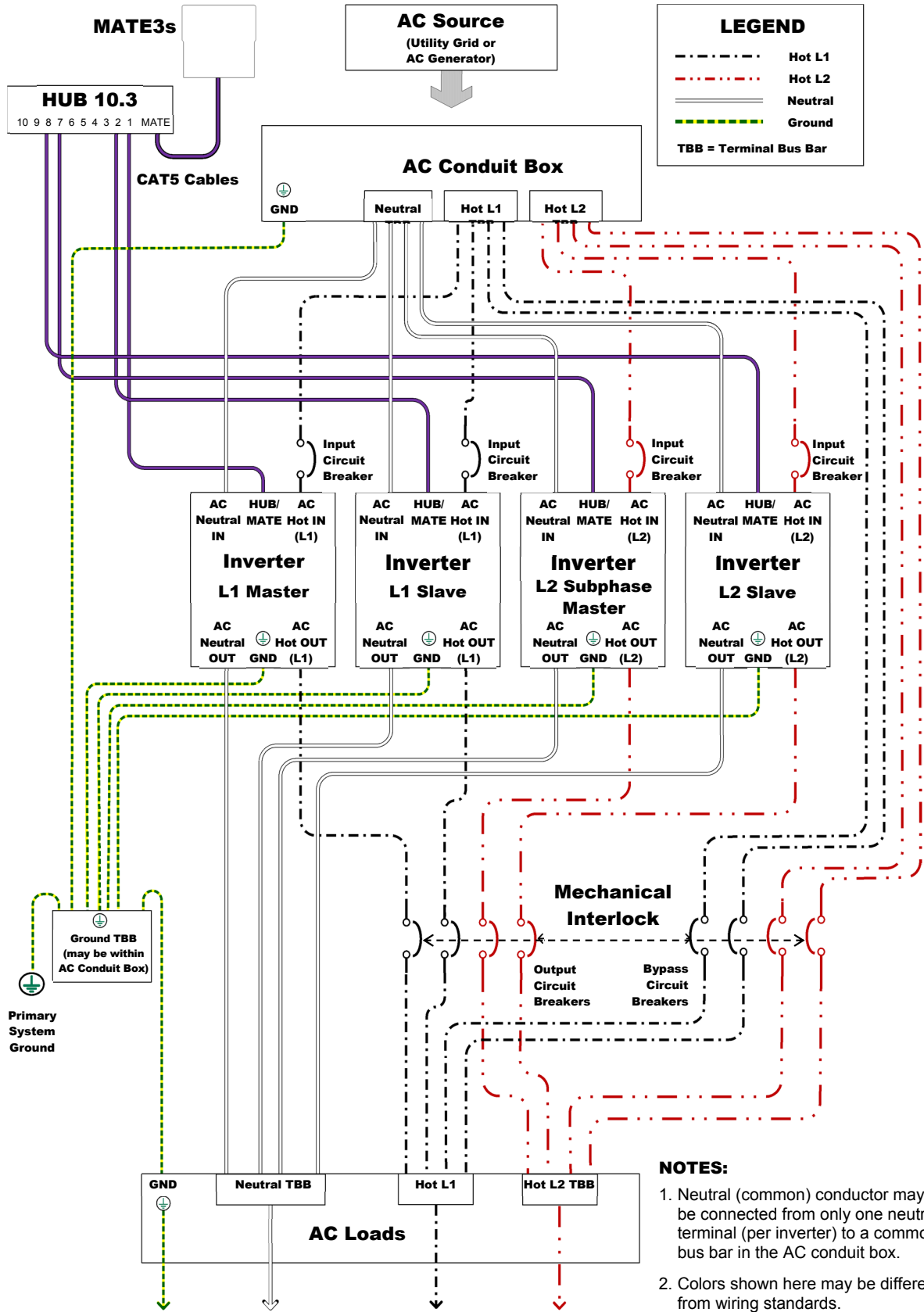
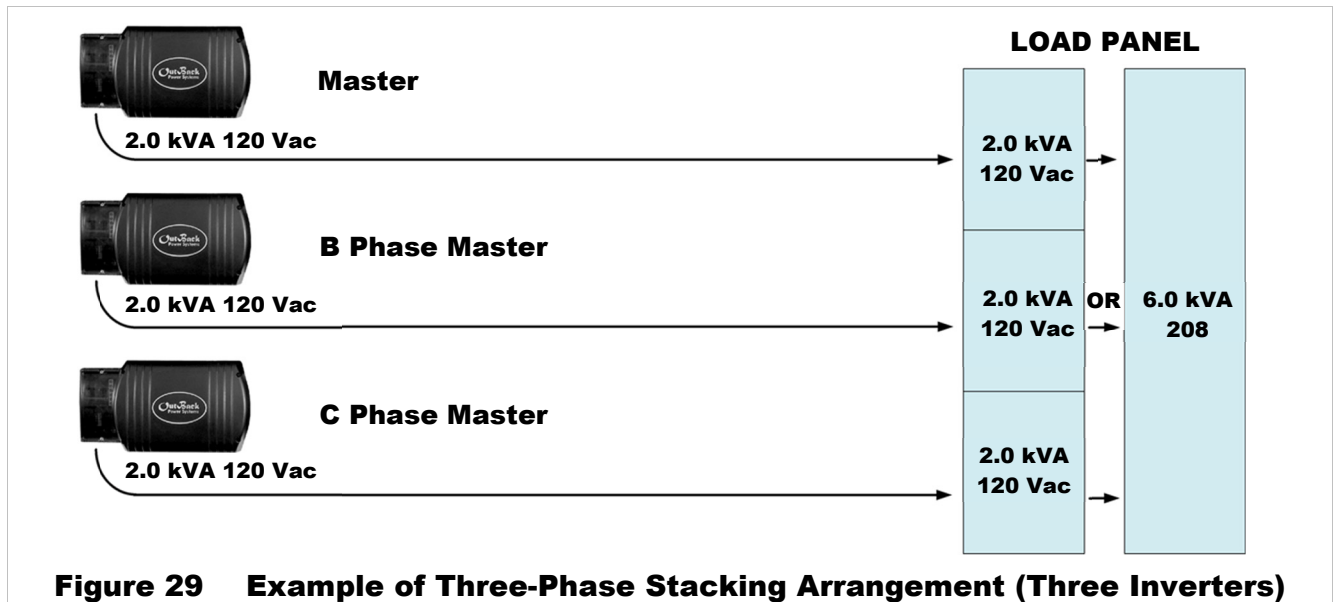

**Figure 28 Series/Parallel Wiring**

## Three-Phase Stacking

In three-phase stacking, inverters create three separate 120 Vac<sup>7</sup> output phases in wye configuration.

- The three phases (A, B, and C) operate independently of each other. The inverters on one phase cannot assist another. Several inverters can be installed in parallel on each phase to power all 120 Vac loads on each of those phases.
- The output of each inverter is 120° out of phase from the others. Any two outputs produce 208 Vac between them. The outputs can be used to power three-phase loads when all inverters work together.
- Up to nine inverters, three per phase, may be installed in a three-phase arrangement. (The wiring drawing on the next page shows only one inverter per phase.) All inverters must be the same model.



**Figure 29 Example of Three-Phase Stacking Arrangement (Three Inverters)**

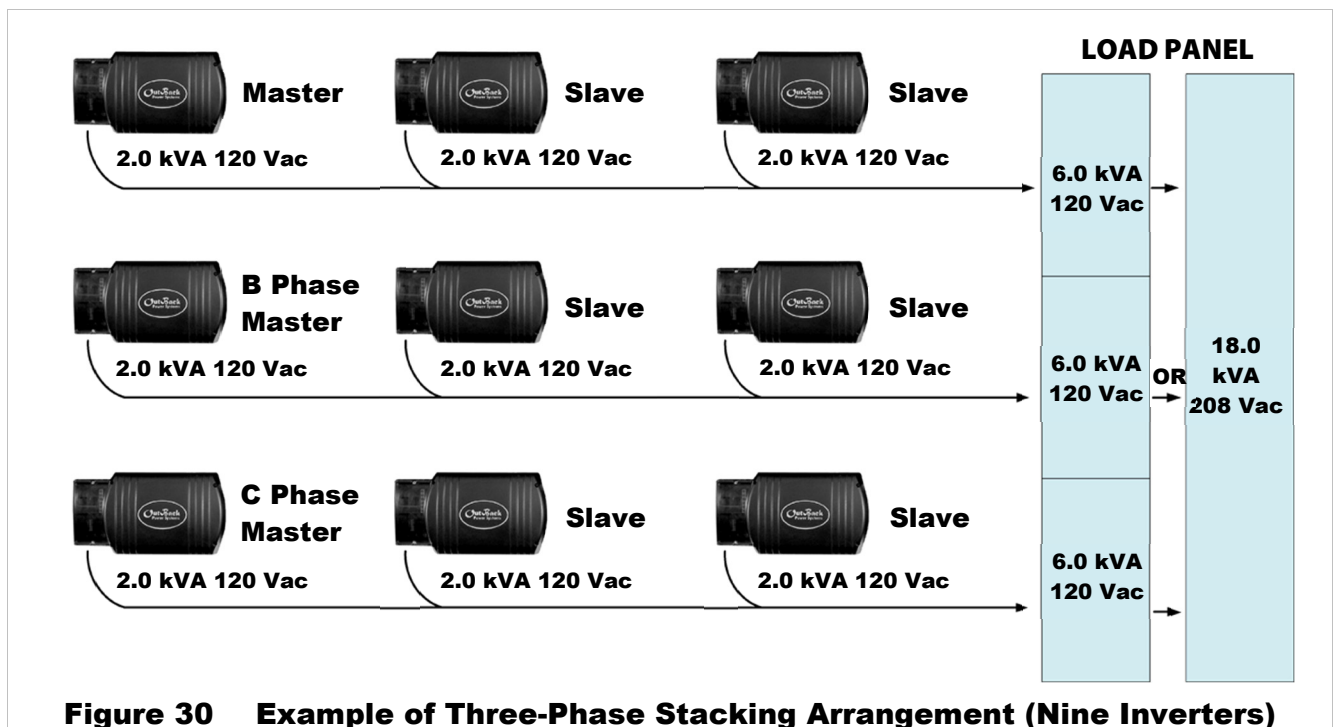

**Figure 30 Example of Three-Phase Stacking Arrangement (Nine Inverters)**

<sup>7</sup> Output voltages may vary with regional voltage standards.

## Installation

When installing a three-phase system, observe the following rules.

- Three-phase stacking requires both the system display and the communications manager. See the HUB10.3 literature for any required jumper configurations.
- The inverter that is mounted physically lowest is always master and is programmed as **Master**.  Mounting below the other inverters allows the master to avoid heat buildup and remain relatively cool as it sees the greatest duty cycle.
- The master must be connected to port 1 of the communications manager. Other inverters must not be selected as master.
- Any other inverter on the Phase A output (parallel with the master) should be assigned as **Slave** during programming. These can be connected to ports 2 or 3. Phase A inverters cannot use other ports.
- The subphase master for the Phase B output must be programmed as **B Phase Master**. It must be connected to port 4.
- Any other inverter on the Phase B output (parallel with the B subphase master) should be assigned as **Slave** during programming. These can be connected to ports 5 or 6. Phase B inverters cannot use other ports.
- The subphase master for the Phase C output must be programmed as **C Phase Master**. It must be connected to port 7.
- Any other inverter on the Phase C output (parallel with the C subphase master) should be assigned as **Slave** during programming. These can be connected to ports 8, 9, or 10. Phase C inverters cannot use other ports.
- All wiring and circuit breakers must be sized appropriately for loads and inverter power.
- The AC input (generator or utility grid) must be a three-phase wye configuration source of the proper voltage and frequency.
- When wiring the AC source to the inverters, local codes may require the inverter circuits to be located at the opposite end of the panel from the main circuit breaker. This prevents overloading of the AC bus.



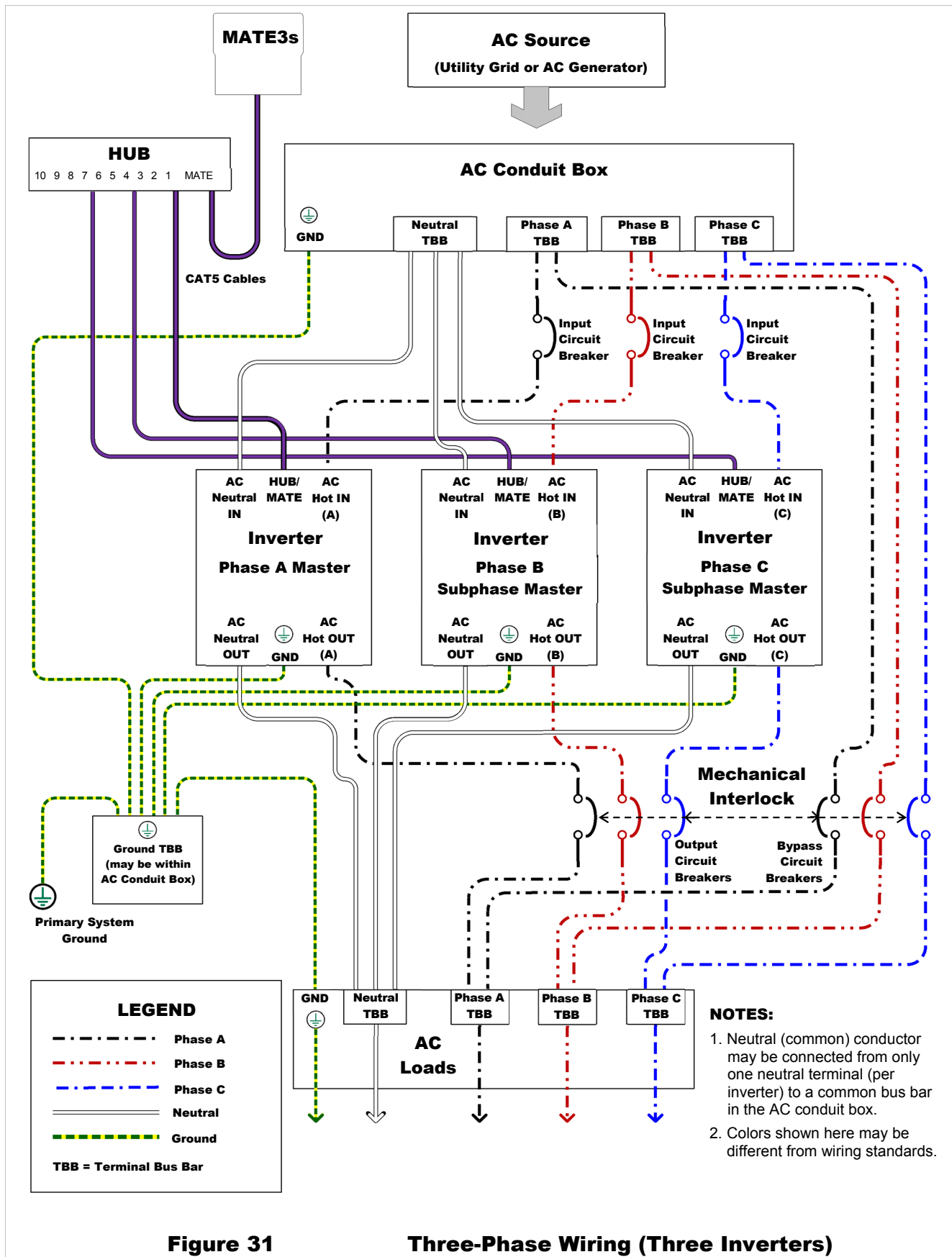

**Figure 31**

**Three-Phase Wiring (Three Inverters)**

## Power Save



### IMPORTANT:

In any system that features slave inverters, **Power Save** must be programmed before commissioning. Leaving the inverters at the factory default settings (or setting them incorrectly) will cause erratic system performance. See the *FXR Series Inverter/Charger Operator's Manual* for a table of menu items and settings. See the system display literature for navigation instructions.

Each FXR inverter uses 34 watts of idle power while turned on, even if it is not actively inverting or charging. The **Power Save** function can put part of a parallel system into a “sleep” state (Silent mode) to minimize the idle consumption. The inverters will activate again when the loads require power. (The term “Silent” is also used in an unrelated context during battery charging.)

- Every time the load increases by an additional 12 Aac, the master inverter activates an additional slave inverter for assistance. When the load decreases to 4 Aac or less **per active inverter** (as detected by the master), one slave is deactivated and returns to Silent mode.
- The order in which slaves activate (or return to Silent mode) is controlled by programming in the system display. The inverters are given a “rank”, or level number. Lower rank numbers activate when lesser loads are applied. Higher ranks only activate when the load increases to a high level.
- The lowest-ranked inverters do not enter Silent mode. This includes the master and subphase master inverters. They remain active unless specifically turned off. These inverters can still enter Search mode.

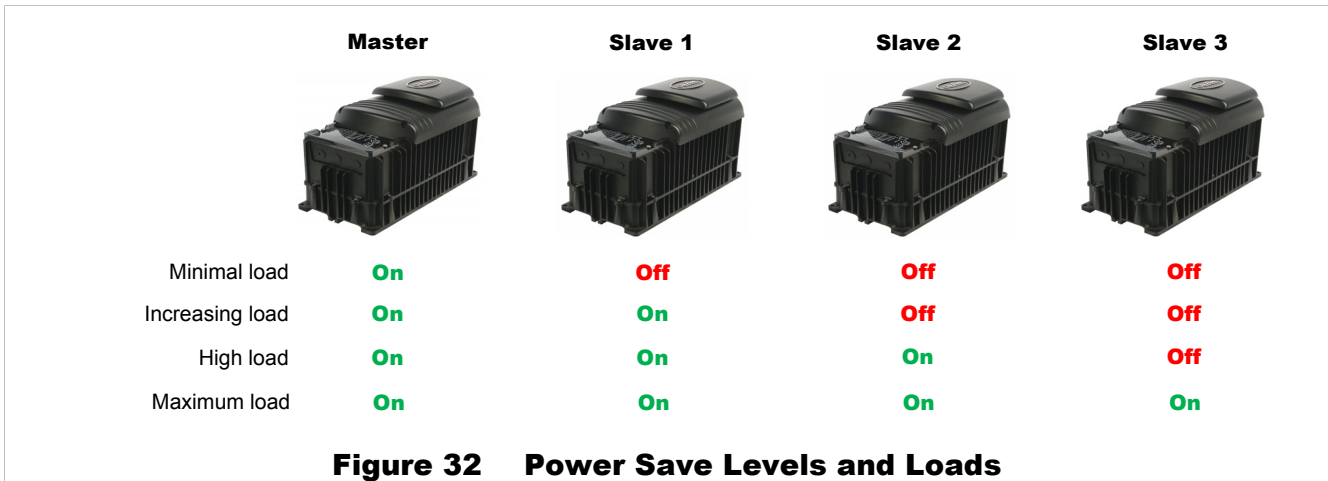

The actual watt and ampere thresholds for activating FXR inverters are depicted on the following pages.



### IMPORTANT:

It is highly recommended to use the Profile Wizard in a MATE3-class system display to set up this function. It is essential to set the slave **Power Save Levels** in sequential order so that they turn on and off correctly. The Profile Wizard automatically programs the correct priorities.

### To set these items manually without the Profile Wizard:

In the system display, the **Power Save Ranking** screen uses **Power Save Level** selections to assign ranks to the inverter on each port. The screen reads **Master Power Save Level** or **Slave Power Save Level**, depending on the inverter’s stacking designation. 

The stacking designations also control which ports are used on the HUB10.3 communications manager. The master inverter must be plugged into port 1. In parallel stacking, any slave inverter can use any other port, beginning with port 2. In series or three-phase stacking, the port

assignments are very specific. They are also different from each other, as illustrated in the HUB10.3 literature. 

- **Master Power Save Level** appears on an inverter which is set as master (the default setting). The range of rank numbers is 0 to 10. The default value is 0. The master is normally left at this value.
  - ~ The **Master Power Save Level** function is used for the master inverter on Port 1. It is also used for any subphase masters in a series or three-phase system. The ranking of a subphase master is treated the same as the master. If the master is set at 0, subphase masters should also be 0.
- **Slave Power Save Level** appears on an inverter which is set as slave. The range of rank numbers is 1 to 10. (The default value for all ports is 1.)
  - ~ When subphase master inverters are in use, the slaves for the additional phases are ranked identically to the slaves on the master phase. If the master inverter has two slaves ranked 1 and 2, any other phases should also rank their slaves 1 and 2. Slaves on multiple phases should not be ranked sequentially (1 through 6 and so on). This would cause delays in output.

The ranks are prioritized so that lower-numbered ranks turn on sooner and higher ranks turn on later. The lowest-ranked inverter does not go silent and remains on unless ordered otherwise. The lowest-ranked inverter is expected to be the master. The priorities are the same across both screens. If Port 1 (master) is set at 0 and Port 2 (slave) is set at 1, the slave will turn on later. Since the **Master** item is the only one that goes to 0, it is easy to ensure that all slave inverters go silent. (To force all slaves to be active, simply set the master at a higher rank than the slaves.)

Subphase master inverters are set at 0 because all phases must have at least one inverter that does not enter Silent mode. The slaves for each phase are set identically to each other so that all phases receive additional power at the same time as needed.



	<p><b>IMPORTANT:</b></p> <p>Set the master (or subphase) rank at 0 and arrange the slave ranks in order (1, 2, 3, 4, etc.). Another order may defeat the purpose of Power Save mode. Leaving the master at 0 makes power available from the master; the other inverters should not be active. If a slave is ranked lower (prioritized higher) than the master, that slave will not go silent.</p> <p><b>NOTE:</b> Disregard this rule if the installation requires some slaves to be continuously active.</p>
	<p><b>IMPORTANT:</b></p> <p>Do not give slave inverters the same rank numbers. If, for example, multiple slaves were all ranked at 1, they would all come on at the same time. Once they came on, the divided load would cause the master to detect a minimal load on its output, so it would shut off all the slaves, at which point the master would read a high load again. This could quickly escalate into a rapid on/off cycling of inverters and could cause long-term system problems.</p>
	<p><b>NOTE:</b></p> <p><b>Power Save</b> is used by the battery chargers of stacked systems with slave inverters. Not every charger is activated at once. Initially the master inverter is the only active charger. The batteries will absorb current up to the maximum for all chargers. When the batteries (and the master) draw more than 12 Aac, the master will turn on the first slave charger. The batteries will absorb that additional current and more. The master will then turn on more slaves until all active chargers are operating.</p> <p>If the master <b>Charger AC Limit</b> is turned to 11 or less, it will not turn on any slaves and will remain the only charger. For more information on charging with stacked inverters, see the <i>FXR Series Inverter/Charger Operator's Manual</i>.</p>

Figure 33 shows a system of four FXR2012A inverters (the master and three slaves). These inverters in a parallel system with a common load bus.

- The captions at the top indicate the ranking of each inverter.
- The captions also show the port assignments on the communications manager (1 through 4).
- The notations at the bottom show how the inverter are activated in sequence as loads of 12 Aac are applied.

# Installation

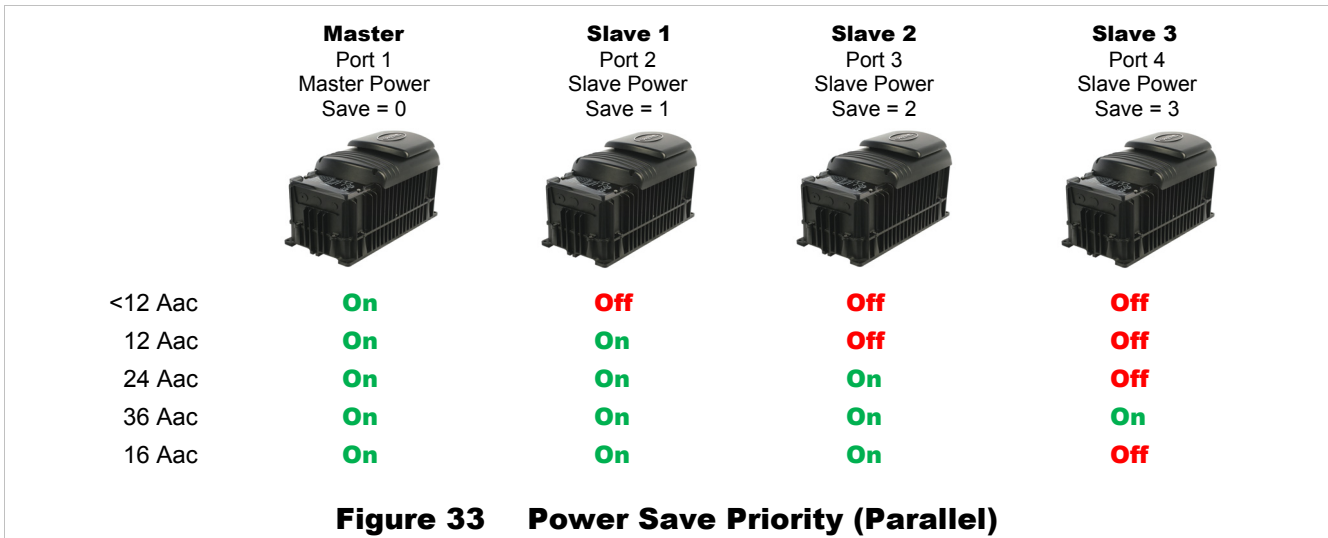

- The fourth line shows that loads of 36 Aac or more (approximately 4 to 4.5 kW) are present on the system. This load causes all four inverters to be activated.
- The last line shows that the loads are reduced to 16 Aac. Since this load is distributed among four inverters, the master reads 4 Aac, the lower threshold for Power Save. This causes one slave to enter Silent mode. The 16 Aac are distributed among the remaining three inverters. If the loads decreased to 12 Aac, a second slave would go silent.

Figure 34 shows a system of six FXR2012A inverters. In this example the inverters have been stacked in a split-phase system. The master inverter is on the L1 output while a subphase master is on L2. Each master has two slave inverters.

- The captions at the top indicate the ranking of each inverter.
- The captions also show the communications manager port assignments. The L1 inverters use ports 1, 2, and 3. However, the communications manager requires the L2 inverters to use ports 7, 8, and 9.
- The notations at the bottom show how the inverters are activated in sequence as loads are applied. The loads on L1 and L2 are not applied equally, so they are not activated at the same time.

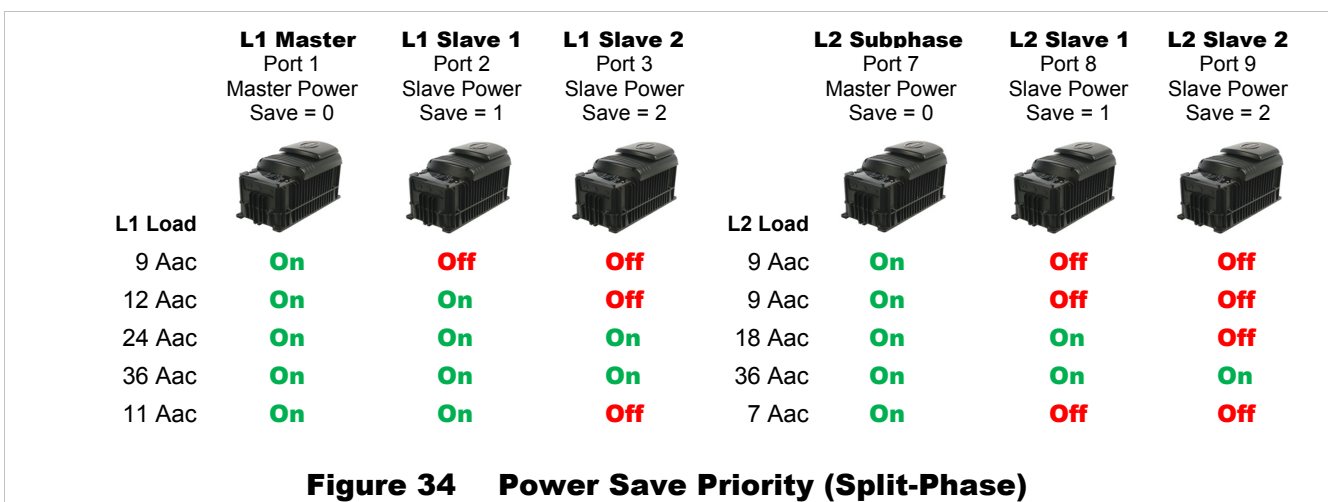

- The fourth line shows that loads of 36 Aac or more (approximately 4 to 4.5 kW) are present on both L1 and L2. This load causes all six inverters to be activated.
- The last line shows that the loads on L1 are reduced to 11 Aac. This causes one slave to go silent. The loads on L2 are reduced to 7 Aac, causing two slaves to go silent.



# Commissioning

## Functional Test



### **WARNING: Shock Hazard and Equipment Damage**

The inverter's AC and DC covers must be removed to perform these tests. The components are close together and carry hazardous voltages. Use appropriate care to avoid the risk of electric shock or equipment damage.

It is highly recommended that all *applicable* steps be performed in the following order. However, if steps are inapplicable, they can be omitted.

- If the results of any step do not match the description, see the *Operator's Manual* for troubleshooting.

## Pre-startup Procedures

1. Ensure all DC and AC overcurrent devices are opened, disconnected, or turned off.
2. Double-check all wiring connections.
3. Confirm that the total load does not exceed the inverter's rated power.
4. Inspect the work area to ensure tools or debris have not been left inside.
5. Using an accurate digital voltmeter (DVM), verify battery voltage. Confirm the voltage is correct for the inverter model. Confirm the polarity.
6. Connect the system display, if present.



### **CAUTION: Equipment Damage**

Incorrect battery polarity will damage the inverter. Excessive battery voltage also may damage the inverter. This damage is not covered by the warranty.



### **IMPORTANT:**

Prior to programming (see **Startup**), verify the operating frequency of the AC source. This is necessary for correct AC operation. The default setting is 60 Hz, but this can be changed to 50 Hz.

## Startup

### **To start a single-inverter system:**

1. Close the main DC circuit breakers from the battery bank to the inverter. Confirm that the system display is operational, if present.
2. If a system display is present, perform all programming for all functions. These functions may include AC input modes, AC output voltage, input current limits, battery charging, generator starting, and others.

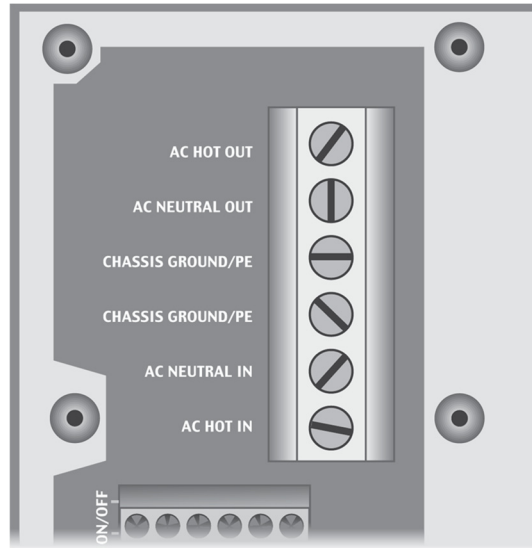

**Figure 35 AC Terminals**

3. Turn on the inverter using the system display (or external switch, if one has been installed). The inverter's default condition is Off. Do not turn on any AC circuit breakers at this time.
4. Using a DVM, verify 120 Vac (or appropriate voltage) between the **AC HOT OUT** and **AC NEUTRAL OUT** terminals. (See Figure 35.) The inverter is working correctly if the AC output reads within 10% of 120 Vac or the programmed output voltage.
5. Proceed past the items below to Step 6 on the next page.

### **To start a multiple-inverter (stacked) system:**

1. Close the main DC circuit breakers from the battery bank to the inverters. Repeat for every inverter present. Confirm that the system display is operational.

With the system display, perform any programming for stacking and all other functions.  These functions may also include AC input modes, AC output voltage, input current limits, battery charging, generator starting, and others. When stacking in parallel, all slave inverters will observe the programming settings of the master inverter. They do not need to be programmed individually. In a MATE3-class system display, the Profile Wizard may be used to assist programming.

2. Turn on the master inverter using the system display (or external switch, if one was installed). The inverter's default state is Off. Do not turn on any AC circuit breakers at this time.
3. Using the system display, temporarily bring each slave out of Silent mode by raising the Power Save Level of the master. (See page 43.)
  - As each slave is activated, it will click and create an audible hum. The green **STATUS INVERTER** indicator LED on that slave will illuminate.
  - Confirm that the system display shows no fault messages.
4. Using a DVM, verify appropriate voltage between the **AC HOT OUT** terminal on the master inverter and the **AC HOT OUT** terminal on each slave. Series inverters should read within 10% of 120 Vac or the programmed output voltage. Parallel inverters should read close to zero. Three-phase inverters should read within 10% of 208 Vac or the designated output voltage.
5. When this test is finished, return the master to its previous Power Save Level.

## After output testing is completed, perform the following steps:

6. Close the AC output circuit breakers. If AC bypass switches are present, place them in the normal (non-bypass) position. Do not connect an AC input source or close any AC input circuits.
7. Use a high-resolution voltmeter to verify correct voltage at the AC load panel.
8. Connect a small AC load and test for proper functionality.
9. Close the AC input circuit breakers and connect an AC source.
  - Using a high-resolution voltmeter, check the **AC HOT IN** and **AC NEUTRAL IN** terminals for 120 Vac (or appropriate voltage) from the AC source.
  - If a system display is present, confirm that the inverter accepts the AC source as appropriate for its programming. (Some modes or functions may restrict connection with the source. If one of these selections has been used for the system, it may not connect.) Check the system display indicators for correct performance.
10. If the charger is activated, the inverter will perform a battery charging cycle after powering up. This can take several hours. If restarted after a temporary shutdown, the inverter may skip most or all of the charging cycle. With the system display, confirm that it is charging as appropriate.
11. Test other functions which have been enabled, such as generator start or search mode.
12. Compare the voltmeter's readings with the system display meter readings. If necessary, the system display's readings can be calibrated to match the voltmeter more accurately. Calibrated settings include AC input voltage, AC output voltage, and battery voltage.

## Powering Down

These steps will completely isolate the inverter.

### To remove power from the system:

1. Turn off all load circuits and AC input sources.
2. Turn off all renewable energy circuits.
3. Turn each inverter Off using the system display or external switch.
4. Turn off the main DC overcurrent devices for each inverter.

## Adding New Devices

When adding new devices to the system, first turn off the system according to the **Powering Down** instructions. After adding new devices, perform another functional test, including programming.

## Operation

Once the mounting, wiring, and other installation steps are completed, proceed to the *FXR Series Inverter/Charger Operator's Manual*.

Refer to the system display literature for programming instructions and menus.

## Firmware Updates



### IMPORTANT:

All inverters will shut down during firmware updates. If loads need to be run while updating the firmware, bypass the inverter with a maintenance bypass switch. Communication cables must remain connected and DC power must remain on. Interrupted communication will cause the update to fail and the inverter(s) may not work afterward. Inverters automatically update one at a time beginning with the highest port. Each requires about 5 minutes.

Updates to the inverter's internal programming are periodically available at the OutBack website [www.outbackpower.com](http://www.outbackpower.com). If multiple inverters are used in a system, all units must be upgraded at the same time. All units must be upgraded to the same firmware revision.



### IMPORTANT:

All stacked FXR inverters must have the same firmware revision. If multiple stacked inverters are used with different firmware revisions, any inverter with a revision different from the master will not function. (See the stacking section on page 31.) The system display will show the following message:

**An inverter firmware mismatch has been detected. Inverters X, Y, Z are disabled. Visit [www.outbackpower.com](http://www.outbackpower.com) for current inverter firmware.**

See the system display *Overview Guide* for instructions on performing updates.



### NOTE:

The MATE3s system display must be used when upgrading the inverter to firmware revision 001.006.063 or higher.

## .GIP File Installation for Grid Support

To enable grid support functionality in different parts of the world, it may be necessary to update the inverter firmware. The .ZIP files for update can be downloaded from the **FXR Grid Support** section of the **Firmware Update** page at [www.outbackpower.com](http://www.outbackpower.com). Each .GIP file available with an update contains a “package” of grid support settings associated with different utility companies or regional standards.



### IMPORTANT:

- ❖ The MATE3s system display is required for this process.
- ❖ Make certain to extract (unzip) all the files before loading all of the contents onto the MATE3s. If the files are loaded to the card in compressed form, they will be unusable.
- ❖ These contents contain a Readme text file which is necessary to the instructions below.

<sup>8</sup> The port designations for the mismatched inverters are listed here.



## To install Grid Support .GIP Files:

1. Perform a firmware update as noted above.

### NOTES:

- The MATE3s should be revision 1.001.000 or greater for Grid Support functionality.
  - For grid-interactive parameters, the Installer Password is required and may need to be changed from the default setting of **1732**. See the *MATE3s Programming Guide* for more information.
2. From the MATE3s **Main Menu (A)** in Figure 36), choose **Firmware Update (B)** and then **FXR Inverter (C)**. The display will show that new firmware is present. (The revision should be 001.006.063 or greater.) Press **Update (D)** to download this firmware into the FXR inverter. This can take up to ten minutes per inverter. In certain systems it may take up to 20 minutes.

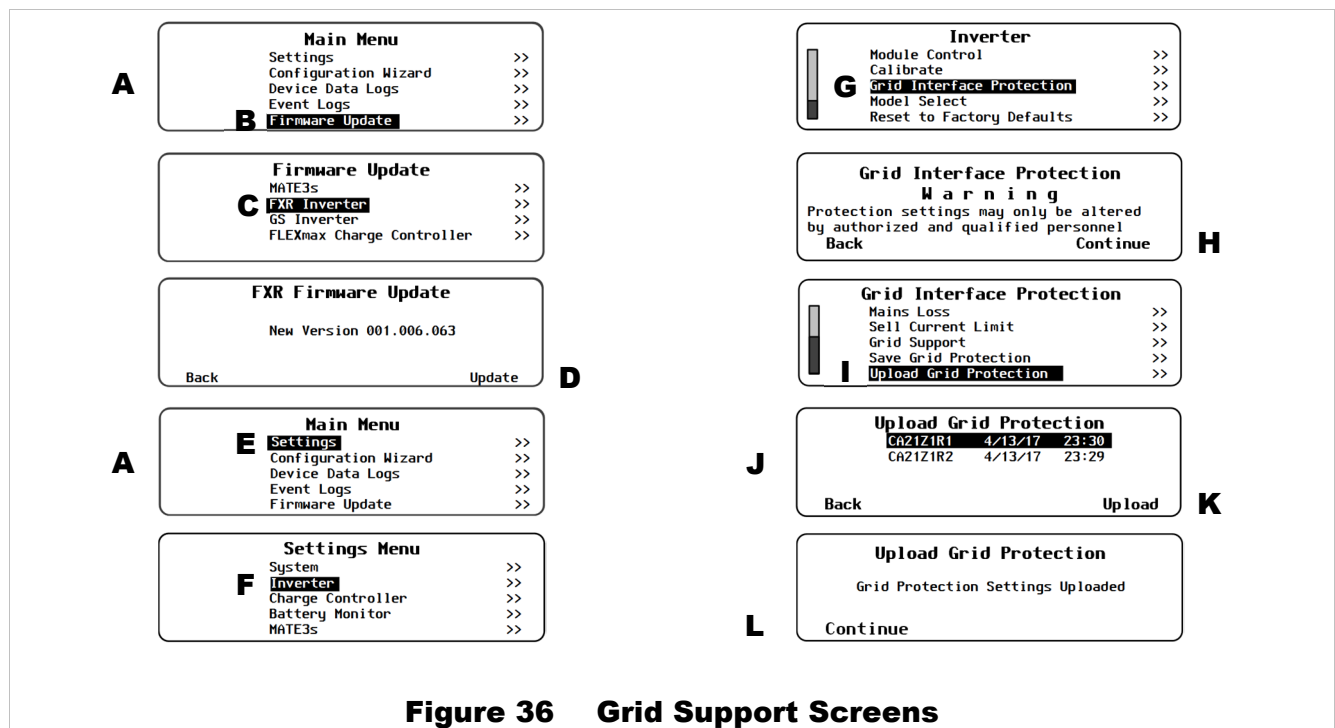

**Figure 36 Grid Support Screens**

3. Press the **<Back>** soft key and then the **UP** key to return to the **Main Menu A**. Select **Settings (E)** followed by **Inverter (F)**. Scroll to **Grid Interface Protection (G)** and press the MATE3s center button. Press **Continue (H)** to enter the menu for protected settings.
4. Scroll to **Upload Grid Protection (I)** and select it with the center button. There are different files for different regions. Options for Hawai'i, Australia, and other locations are available.
5. In the **Upload Grid Protection** screen (**J**), scroll to the .GIP file that is required by the utility. See the spreadsheet file and ReadMe text file (in the download folder) to identify the correct .GIP file to be loaded and the values included in each .GIP file.
6. Press the **<Restore>** soft key (**K**) to install the selected settings.
7. A confirmation screen will appear. Press **Continue (L)** to exit to the **Main Menu A**.

**The update and settings are now complete.**

## Preventative Maintenance

The FXR inverter requires almost no regular maintenance. However, OutBack recommends the following items on a periodic basis:

- Check all electrical connections periodically for tightness using the torque values from pages 18 through 20.
- For vented (VFXR) models, clean the air filter inside the DC cover every three months. (See page 22 to remove the cover.) Rinse the filter with warm tap water and allow it to fully air-dry before reinstalling. Do not use any cleaning solutions.
- Check the batteries according to the recommendations and schedule provided by the battery manufacturer. Perform equalization as appropriate. 

## Definitions

**Table 6 Terms and Definitions**

<b>Term</b>	<b>Definition</b>
AC Plate	Inverter accessory to accommodate flexible cable when conduit is not used
AGS	Advanced Generator Start
<b>Aux</b>	Inverter's 12-volt auxiliary output
Communications manager	Multi-port device such as the OutBack HUB10.3; used for connecting multiple OutBack devices on a single remote display; essential for stacking inverters
CSA	Canadian Standards Association; establishes Canadian national standards and the Canadian Electrical Code, including C22.1 and C22.2
DCC	DC Cover; shields the DC terminal area on vented FXR inverters
ETL	Electrical Testing Laboratories; short for the company ETL Semko (Intertek); refers to a certification issued by ETL to OutBack products indicating that they meet certain UL standards
GFDI	Ground Fault Detector Interruptor; a safety device for PV systems
GND	Ground; a permanent conductive connection to earth for safety reasons; also known as Chassis Ground, Protective Earth, and PE
Grid-interactive, grid-intertie, grid-tie	Utility grid power is available for use and the inverter is capable of returning (selling) electricity back to the utility grid
HUB10.3	An OutBack communications manager product; used for system stacking and coordination
IEC	International Electrotechnical Commission; an international standards organization
Invert, inverting	The act of converting DC voltage to AC voltage for load use or other applications
LED	Light-Emitting Diode; refers to indicators used by the inverter and the system display
Master	An inverter which provides the primary output phase of a stacked system; other stacked inverters base their output and on/off state on the master

**Table 6      Terms and Definitions**

<b>Term</b>	<b>Definition</b>
NEU	AC Neutral; also known as Common
Neutral-to-ground bond	A mechanical connection between the AC neutral (Common) bus and the ground (PE) bus; this bond makes the AC neutral safe to handle
Off-grid	Utility grid power <i>is not</i> available for use
On-grid	Utility grid power is available for use (does not imply grid-interactive capability)
PV	Photovoltaic
RE	Renewable Energy
RTS	Remote Temperature Sensor; accessory that measures battery temperature for charging
Slave	An inverter which adds additional power to the master or subphase master in a stacked system; a slave does not provide an output of its own
Split-phase	A type of utility electrical system with two “hot” lines that typically carry 120 Vac with respect to neutral and 240 Vac with respect to each other; common in North America
Subphase Master	An inverter which provides the output for additional phases of a stacked system; the phase of a subphase master is based on the output of the master
System display	Remote interface device (such as the MATE3s), used for monitoring, programming and communicating with the inverter; also called “remote system display”
Three-phase, 3-phase	A type of utility electrical system with three “hot” lines, each 120° out of phase; each carries the nominal line voltage with respect to neutral; each carries voltage with respect to each other equaling the line voltage multiplied by 1.732
Turbo Fan	External cooling fan used in place of the DCC on sealed FXR inverters
UL	Underwriters Laboratories; refers to a set of safety standards governing electrical products
Utility grid	The electrical service and infrastructure supported by the electrical or utility company; also called “mains”, “utility service”, or “grid”





# Index

## A

AC Plate .....	7
AC Terminals .....	9, 17, 23
AC Test Points .....	46
Adding New Devices .....	47
Advanced Generator Start (AGS) .....	26, 28
Applications .....	9
AUX Terminals .....	17
AXS Port .....	6

## B

Battery Bank .....	11
Sizing .....	12
Battery Terminal Covers .....	7, 21, 22

## C

Caution Symbol .....	5
Charging Current .....	43
Clearance .....	15
Commissioning .....	45
Communication Cables .....	17, 26, 31
Communications Manager	
Connections .....	17, 26, 31
Stacking .....	33, 35, 37, 39
Components .....	7
Conductor Size	
AC Conductors .....	23
DC Conductors .....	20
Ground Conductors .....	18
Control Wiring Terminal Block .....	17
CSA .....	6

## D

DC Cover (DCC) .....	7, 15, 22
DC Terminals .....	17, 20, 21
DC Wiring .....	20
Definitions .....	50
Dimensions .....	16
Diversion Control .....	27
Drawings	
AUX Connection .....	27
General System Layout .....	9
Generator Control .....	28, 29

Multiple AC Sources .....	24
Parallel-Stacked System .....	35, 36
Series/Parallel System .....	37, 38
Series-Stacked System .....	33, 34
Single-Inverter System .....	30
Three-Phase System .....	41
Transfer Relay .....	24
DVM .....	15, 45, 46

## E

Environmental Requirements .....	15
----------------------------------	----

## F

Features .....	6
Firmware .....	48, 49
FLEXware .....	15
Functional Test .....	45

## G

Gen Alert .....	28
Generator .....	30, 33, 35, 37, 39
Applications .....	9, 24
Automatic Control .....	26
Requirements .....	14
Three-Wire .....	29
Two-Wire .....	28
Control .....	28, 29
Sizing .....	14
Type .....	14
GFCI .....	24
GFDI .....	18, 50
GIP File .....	48, 49
Grid Support .....	9, 10, 48, 49
Grid-Interactive .....	9, 50
Grounding .....	17, 18

## H

HUB10.3 .....	26, 31
---------------	--------

# Commissioning

## I

IEC .....	18, 50
Important Symbol.....	5
Ingress Protection (IP).....	15
Input Modes .....	10

## J

Jumper.....	17, 25
-------------	--------

## L

LED Indicators .....	17
Listings.....	6
Location .....	15

## M

Maintenance Checks .....	50
Master (Stacking).....	31, 33, 35, 37, 39
MATE/HUB Port.....	26
MATE3s, MATE3-class .....	6, 42, 49
AUX .....	26
Stacking.....	31
Models .....	7
Modes .....	10
Mounting .....	15
Dimensions.....	16
Plate .....	15
Multiple AC Sources .....	24

## N

Neutral-Ground Bonding.....	14, 18, 23
Note Symbol .....	5

## O

On and Off .....	17, 25
OPTICS RE .....	6

## P

Parallel Stacking.....	35, 36
Ports, RJ45 and RJ11 .....	17, 26
Positive Grounding .....	18
Power Save .....	42
Powering Down.....	47
PV .....	9, 11

## R

Ranks, Power Save .....	42
Relative Humidity (RH).....	15
Remote System Display .....	51

Remote Temperature Sensor (RTS).....	7, 17, 26
Renewable Energy.....	11
Revision .....	48, 49

## S

Sealed Models .....	7, 15
Series Stacking .....	33, 34
Series/Parallel Stacking .....	37, 38
Silent	
Power Save .....	42
Sizing.....	30
Slave (Stacking).....	31, 35, 37, 39
Stacking .....	31, 48
Commissioning .....	46
Parallel.....	35, 36
Power Save .....	43
Series.....	33, 34
Series/Parallel.....	37, 38
Three-Phase .....	39, 41
Startup.....	45
Subphase Master (Stacking).....	31, 33, 34, 37, 39
Switch.....	17, 25
Symbols Used .....	5
System Display .....	47, 51
Connections.....	17, 26
Programming .....	14, 26, 28, 31
Stacking .....	33, 35, 37, 39

## T

Temperatures.....	15
Terms and Definitions .....	50
Test .....	45
Test Points .....	46
Three-Phase Stacking.....	39, 41
Tools Required.....	15
Torque Requirements	
DC Terminals.....	20
Ground Terminals.....	18
Transformer.....	14
Turbo Fan.....	7, 22

## U

UL 1741.....	6
Updating Firmware.....	48
Utility Grid.....	30, 33, 35, 37, 39, 51
Applications .....	9, 24

## V

Vent Fan.....	27
Vented Models .....	7, 15

# Index

## **W**

Warning Symbol .....	5
Website .....	48
Wiring .....	18
AC Connections .....	23
AUX Connections .....	26
DC Connections .....	20
Ground Connections .....	18
Parallel Inverters .....	35
Series Inverters .....	33, 34
Single Inverter .....	30
Stacking	
Parallel .....	36
Series .....	33
Series/Parallel .....	37, 38
Three-phase .....	41

## **X**

XCT .....	17
-----------	----



**Masters of the Off-Grid.™ First Choice for the New Grid.**

Corporate Headquarters  
17825 – 59<sup>th</sup> Avenue N.E.  
Suite B  
Arlington, WA 98223 USA

European Office  
Hansastraße 8  
D-91126  
Schwabach, Germany